



Series SD31

User's Manual



Single Display PID Controller



**TOTAL
CUSTOMER
SATISFACTION**
3 Year Warranty



ISO 9001

Registered Company
Winona, Minnesota USA

1241 Bundy Boulevard., Winona, Minnesota USA 55987
Phone: +1 (507) 454-5300, Fax: +1 (507) 452-4507 <http://www.watlow.com>



Safety Information

We use note, caution and warning symbols throughout this book to draw your attention to important operational and safety information.

A “NOTE” marks a short message to alert you to an important detail.

A “CAUTION” safety alert appears with information that is important for protecting your equipment and performance. Be especially careful to read and follow all cautions that apply to your application.

A “WARNING” safety alert appears with information that is important for protecting you, others and equipment from damage. Pay very close attention to all warnings that apply to your application.

The safety alert symbol,  (an exclamation point in a triangle) precedes a general CAUTION or WARNING statement.

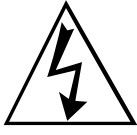
The electrical hazard symbol,  (a lightning bolt in a triangle) precedes an electric shock hazard CAUTION or WARNING safety statement.



**CAUTION or
WARNING**

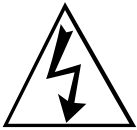

**Electrical
Shock Hazard**

CAUTION or WARNING

Technical Assistance

If you encounter a problem with your Watlow controller, review your configuration information to verify that your selections are consistent with your application: inputs, outputs, alarms, limits, etc. If the problem persists, you can get technical assistance from your local Watlow representative (see back cover), by e-mailing your questions to wintechsupport@watlow.com or by dialing +1 (507) 494-5656 between 7 a.m. and 5 p.m., Central Standard Time (CST). Ask for for an Applications Engineer. Please have the following information available when calling:

- Complete model number
- All configuration information
- User’s Manual
- Factory Page

Warranty

The Series SD31 is manufactured by ISO 9001-registered processes and is backed by a three-year warranty.

Return Material Authorization (RMA)

1. Call Watlow Customer Service, (507) 454-5300, for a Return Material Authorization (RMA) number before returning any item for repair. If you do not know why the product failed, contact an Application Engineer or Product Manager. All RMA’s require:

- Ship to address
- Contact name
- Method of return shipment
- Detailed description of the problem
- Name and phone number of person returning the product.
- Bill to address
- Phone number
- Your P.O. number
- Any special instructions

2. Prior approval and an RMA number, from the Customer Service Department, is needed when returning any unused product for credit. Make sure the RMA number is on the outside of the carton and on all paperwork returned. Ship on a Freight Prepaid basis.

3. After we receive your return, we will examine it and try to verify the reason for returning it.

4. In cases of manufacturing defect, we will enter a repair order, replacement order or issue credit for material returned. In cases of customer mis-use, we will provide repair costs and request a purchase order to proceed with the repair work.

5. To return products that are not defective, goods must be in new condition, in the original boxes and they must be returned within 120 days of receipt. A 20 percent restocking charge is applied for all returned stock controls and accessories.

6. If the unit is unrepairable, you will receive a letter of explanation. and be given the option to have the unit returned to you at your expense or to have us scrap the unit.

7. Watlow reserves the right to charge for no trouble found (NTF) returns.

The Series SD31 User’s Manual is copyrighted by Watlow Winona, Inc., © April 2003 with all rights reserved. (2361)

Table of Contents

- Chapter 1: Overview**2
- Chapter 2: Install and Wire**4
 - Dimensions and connectors4
 - Installing and removing the SD315
 - Wiring the Series SD316
- Chapter 3: Keys and Displays**14
 - Home Page Overview14
 - Adjusting the control set point15
 - Operations Page Overview15
 - Setup Page Overview16
 - Programming Page Overview17
 - Factory Page Overview17
- Chapter 4: Home Page**18
- Chapter 5: Setup Page**19
- Chapter 6: Operations Parameters Table**26
- Chapter 7: Factory Page and Calibration**30
 - Calibrating the Series SD3133
 - Restoring Factory Calibration34
- Chapter 8: Features**36
 - Saving and Restoring User Settings37
 - Operations Page37
 - Autotuning37
 - Manual Tuning38
 - Inputs38
 - Control Methods40
 - Alarms44
 - Communications46
 - Troubleshooting48
 - Error Messages50
- Appendix**51
 - Specifications51
 - Ordering Information53
 - Index54
 - Prompt Index56
 - Declaration of Conformity Inside Back Cover

1

Overview

The Watlow Series SD31 PID, is a microprocessor-based temperature controller available in the 1/32 DIN panel mount size. The Series SD31 has a single, universal input that accepts various thermocouples, RTDs (resistive temperature devices) or process inputs. (See the Specifications in the Appendix for further details).

The Series SD31 PID controller offers up to two outputs. Outputs can be configured as heat, cool, alarm or off (deactivated). The control outputs can be independently configured for PID or On-Off control. PID settings include proportional band, reset (or integral) and rate (or derivative).

Standard Series SD31 features include an IP65/NEMA 4X front panel rating; CE compliance, UL, CUL, CSA and NSF agency approvals: single, four-digit displays in red or green; autotuning for heat and cool outputs; ramp to set point, to gradually warm up your thermal system; and automatic/manual capability with bumpless transfer. A low-voltage model is also available.

Advanced features include Modbus, EIA-485 serial communications to interface with PC software applications; and INFOSENSE™ technology that provides low-cost, high-accuracy thermal sensing.

Other operator-friendly features include LED indicators to aid in monitoring and setting up the controller, as well as a calibration offset at the front panel. The Watlow Series SD31 automatically stores all information in non-volatile memory and provides an additional back-up for user-selected settings.

For more information on these and all other product features, refer to the Features Chapter and the Appendix.

Features and Benefits

INFOSENSE™ Technology

- Improves sensor accuracy by a minimum of 50%.

User Definable Menu System

- Simplifies operator interface

User Definable Default Settings

- Restores to user defined controller settings

Advanced Control Algorithm

- Improved process control.

WATVIEW™ Software

- Operation, configuration and data logging with a standard Windows® PC.

Up to Two Outputs

- Application versatility.
- Configuration flexibility.

Ramp to Set Point

- Controls the rate of temperature changes.



Figure 2 — Series SD31 inputs and outputs.

How to use the Series SD31 controller

Before you use your Series SD31 controller, it must be installed and configured correctly. **Which setup steps you need to perform will depend on how you will use it.**

If you purchased the controller to design into your products:

You will need to do the first three steps and maybe some of the fourth step. Some wiring, such as the final wiring of a communications connection or an alarm output for signaling an external device, might be left to the end user. In highly specialized applications with little variation in operation and heat load, the OEM might configure almost all the parameters.

If you purchased the controller to design and install into new equipment for your own use or to retrofit into existing equipment:

You will need to complete all four steps.

If you purchased the controller installed in equipment designed around it:

You will probably only need to do the fourth step. In some instances, you may need to wire it for serial communications and/or an alarm output. Some serial communications parameters on the Setup Page may need to be changed.

Step 1: Mount and install the controller.

The Series SD31 controller is designed to be panel mounted in a standard DIN opening. It is a 1/32 DIN size controller. Cut the correct size hole into the panel and mount the controller, using its mounting brackets. See Chapter Two for details on installation and mounting.

If you retrofit the Series SD31 controller into an existing application, you may need to use a Watlow adapter plate to adapt it to the smaller controller size.

Step 2: Wire the controller.

The controller will need to have its power, input and output wiring installed. The wiring depends on the specific model number of the Series SD31 controller. The dimension illustrations in Chapter Two show the location of the model number. Use the model number to determine which wiring diagrams to follow for your controller. See Chapter Two for wiring details.

Step 3: Configure the Setup Page.

Setup Page parameters tell the controller what input and output devices are wired to the controller and how the controller should function. Without the proper Setup Page settings, the controller will not operate or could operate erratically. Since these settings require detailed knowledge on the wiring and operation of the equipment, the OEM or the designer normally programs these parameters. Some settings, such as the baud rate or controller address, are Setup Page parameters, but would probably be set by the end user.

These settings should be recorded for future reference. The settings can also be stored using the **USr5** parameter, on the Factory Page. For saving and restoring parameters, see Chapter Eight, Features. For details on configuring the Setup Page, see Chapter Five, Setup Page.

Step 4: Configure the Operations Page.

The Operations Page contains the parameters that the equipment operator may need to set or change from time to time. This includes calibration offset, autotune, PID parameters and alarm set points. In some cases the OEM manufacturer may set most of these parameters because the equipment operates with little variation (i.e., always the same temperature, always the same heat load). In equipment where demands could vary significantly, the OEM may leave parameter adjustments to the end user (i.e., many different temperature settings, different heat loads).

The Operations Page on the Series SD31 controller is customizable so that only the parameters that the operator may need to use will appear in the display. Settings that won't need to be adjusted can be hidden from the operator, using the Programming Page. For more details on the Programming Page, see Chapter Eight, Features. For details on configuring parameters on the Operations Page, see Chapter Six, Operations Parameters Tables. Once you have verified the controller is operating properly, be sure to document all of your parameter settings. **Each parameter table has a settings column for you to write in your values.**



Caution: Follow the installation procedure exactly to guarantee a proper IP65/NE-MA 4X seal. Make sure the gasket between the panel and the rim of the case is not twisted and is seated properly. Failure to do so could result in damage to equipment.

Note: Contact your local Greenlee supplier for the appropriate punch kit and cutout tools required for rapid mounting.

2 Install and Wire

Series SD31 Controller Dimensions

Front

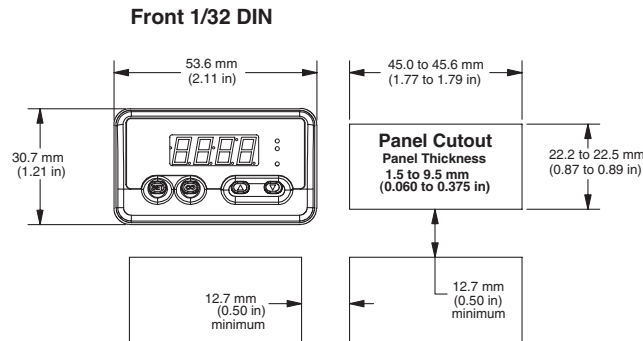

Top

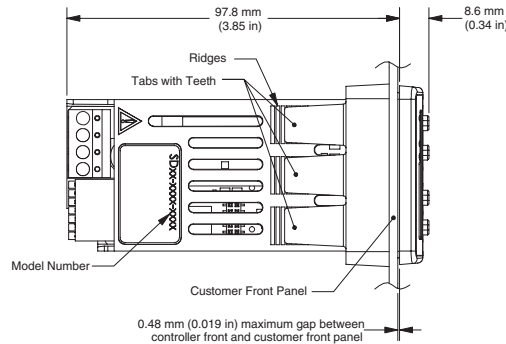

Back

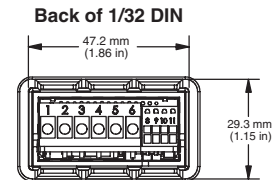

Figure 4a — Dimensions

To remove spring clamp connector, pull straight back.

To remove screw clamp connector, pull straight up.

Spring clamp wiring connector note:

To insert the wire, push the wire into the desired connection number, and it should automatically lock into place. To remove the wire, press and hold the orange release tab with a small screwdriver. Pull the wire out of the connection. Solid or tinned wire recommended.

Series SD31 — Wiring Connectors

Figure 4b — SD31 with a Universal Process Output installed for output 1 (S D 3 1 - _ F _ _ _ _ _).

Figure 4c — SD31 with other than a Universal Process Output installed for output 1 (S D 3 1 - _ (C,K or J) _ _ _ _ _).

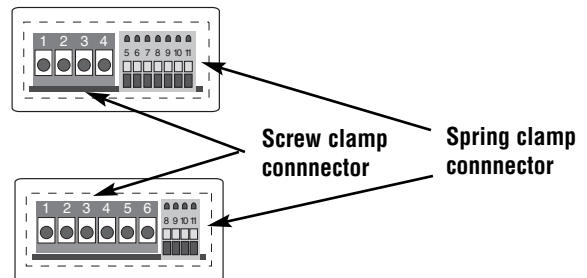

NOTE: The SD31 model number determines which connector diagram applies to your unit.



Caution: Follow the installation procedure exactly to guarantee a proper IP65/NEMA 4X seal. Make sure the gasket between the panel and the rim of the case is not twisted and is seated properly. Failure to do so could result in damage to equipment.

Installing the Series SD31 Controller

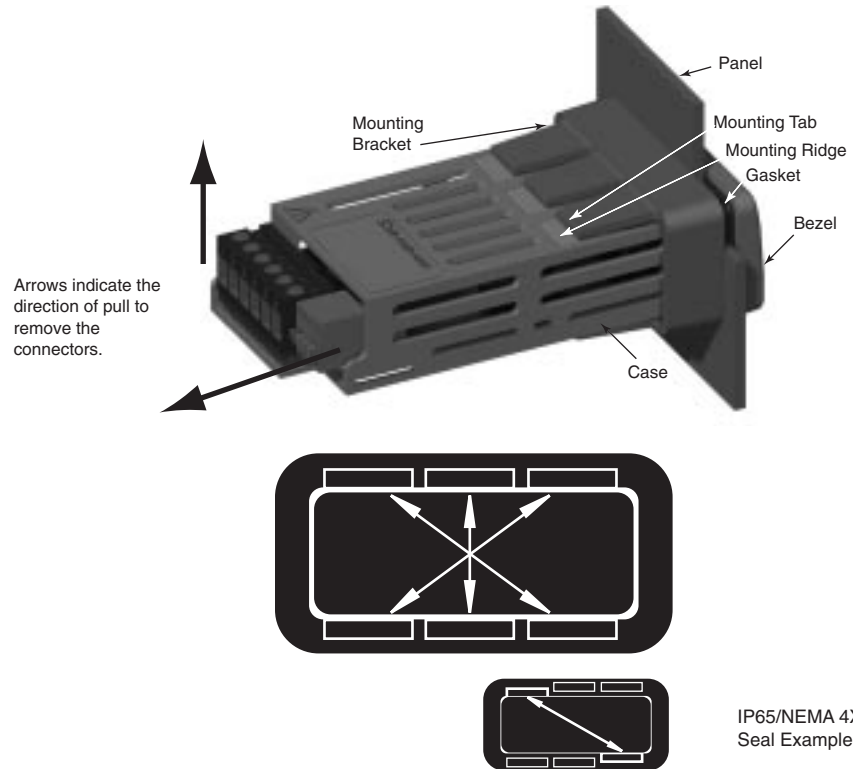

1. Make the panel cutout using the mounting template dimensions in this chapter.
2. Check that the rubber gasket lies in its slot at the back of the bezel. Insert the controller into the panel cutout.
3. While pressing the bezel firmly against the panel, slide the mounting bracket over the back of the controller.
4. If the installation does not require an IP65/NEMA 4X seal, slide the bracket up to the back of the panel enough to eliminate the spacing between the gasket and the panel.

For an IP65/NEMA 4X seal, use your thumb to lock the tabs into place while pressing the controller from side to side. Don't be afraid to apply enough pressure to properly install the controller. If you can move the controller back and forth in the cutout, you do not have a proper seal. The tabs on each side of the bracket have teeth that latch into the ridges.

Each tooth is staggered at a different depth (from the front) so only one of the tabs on each side is ever locked into the ridges at any time. Either the two middle tabs or the two tabs diagonal from each other will be engaged.

5. If the matching tabs are not engaged, you do not have an IP65/NEMA 4X seal. The space between the bezel and panel must be 0 to 0.48 mm (0 to 0.019 in) maximum.

Removing the SD31 Controller

1. Remove all the wiring connectors from the back of the controller.
2. Slide a thin, wide tool (putty knife) under all three mounting tabs on the top and then the bottom, while pushing forward on the back of the case. Be ready to support the controller as it slides out of the panel cutout.



Warning:

Use National Electric (NEC) or other country-specific standard wiring and safety practices when wiring and connecting this controller to a power source and to electrical sensors or peripheral devices. Failure to do so may result in damage to equipment and property, and/or injury or loss of life.

Spring clamp wiring connector note:

To insert the wire, push the wire into the desired connection number, and it should automatically lock into place. To remove the wire, press and hold the orange release tab with a small screwdriver. Pull the wire out of the connection. Solid or tinned wire recommended.



WARNING: If high voltage is applied to a low-voltage controller, irreversible damage will occur.

Wiring the Series SD31

Isolation Blocks

There are no electrical connections between these blocks.

Sensor Input
Switched DC Outputs
Analog Process Outputs

Power Supply Input

EIA/TIA-485 Communications Input

Relay outputs (mechanical and solid-state) provide isolation through their relay contacts. Each relay output is isolated from the blocks above and is isolated from other relay outputs.

The model number for each output option appears with its wiring diagram. Check the label on the controller and compare your model number to those shown here and to the model number breakdown in the Appendix of this manual.

The connectors on the back of the Series SD31 are different for different model numbers. See page 4. Where two different combinations of connectors may appear, we show both in the diagrams.

All outputs are referenced to a de-energized state.

All wiring and fusing must conform to the National Electric Code and to any locally applicable codes as well.

Figure 6a — High Voltage AC Power Wiring

SD31 - H _ _ _ - _ _ _ High

- Nominal voltage: 100 to 240V~ (ac)

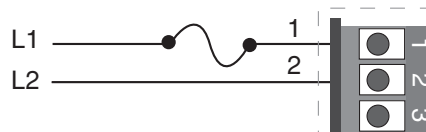
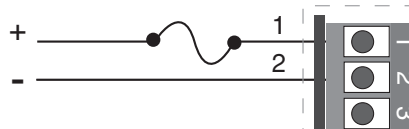

Figure 6b — Low Voltage AC Power Wiring

SD31 - L _ _ _ - _ _ _ Low

- Nominal voltage: 24V~ (ac/dc)
- Class 2 power source required for agency compliance





Warning:
Use National Electric (NEC) or other country-specific standard wiring and safety practices when wiring and connecting this controller to a power source and to electrical sensors or peripheral devices. Failure to do so may result in damage to equipment and property, and/or injury or loss of life.

Spring clamp wiring connector note:
To insert the wire, push the wire into the desired connection number, and it should automatically lock into place. To remove the wire, press and hold the orange release tab with a small screwdriver. Pull the wire out of the connection. Solid or tinned wire recommended.

Note: To prevent ground loops, isolation needs to be maintained from input to output when using switched DC or analog process outputs.



WARNING: Process input may not have sensor break protection. Outputs can remain full on.

Figure 7a — Thermocouple Input

(all model numbers)

Thermocouples are polarity sensitive. The negative lead (usually red) must be connected to terminal 11.

- Input impedance: >20 MΩ

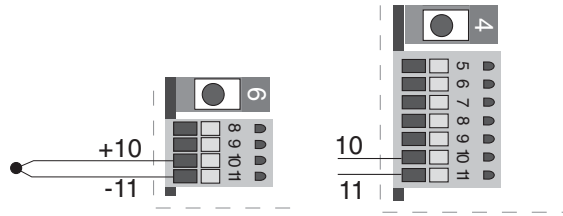

Figure 7b — RTD Input (100 Ω DIN curve 0.00385 Ω/Ω/°C)

(all model numbers)

Terminals 8 and 11 must be shorted for a two-wire RTD. For three-wire RTDs, the S1 lead (usually white) must be connected to terminal 10.

- Nominal excitation current: 390 μA

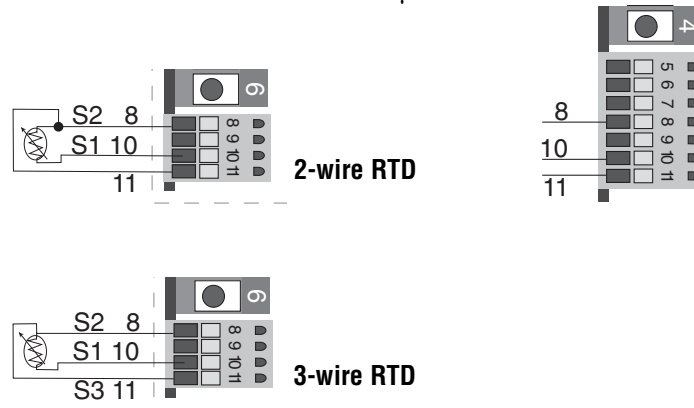
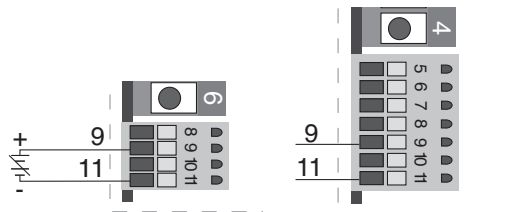

Figure 7c — 0 to 10V_{DC} (dc) Process Input

(all model numbers)

- Input impedance 20 kΩ, dc only





WARNING: Process input may not have sensor break protection. Outputs can remain full on.



Warning:
Use National Electric (NEC) or other country-specific standard wiring and safety practices when wiring and connecting this controller to a power source and to electrical sensors or peripheral devices. Failure to do so may result in damage to equipment and property, and/or injury or loss of life.

Quencharc Note:
Switching pilot duty inductive loads (relay coils, solenoids, etc.) with the mechanical relay or solid-state relay output options requires use of an R.C. suppressor.

Watlow carries the R.C. suppressor Quencharc brand name, which is a trademark of ITW Paktron. Watlow Part No. 0804-0147-0000.

Spring clamp wiring connector note:
To insert the wire, push the wire into the desired connection number, and it should automatically lock into place. To remove the wire, press and hold the orange release tab with a small screwdriver. Pull the wire out of the connection. Solid or tinned wire recommended.

Figure 8a — 0 to 20 mA Process Input

(all model numbers)

- Input impedance 100 Ω , dc only
- Controller does not supply power for the current loop

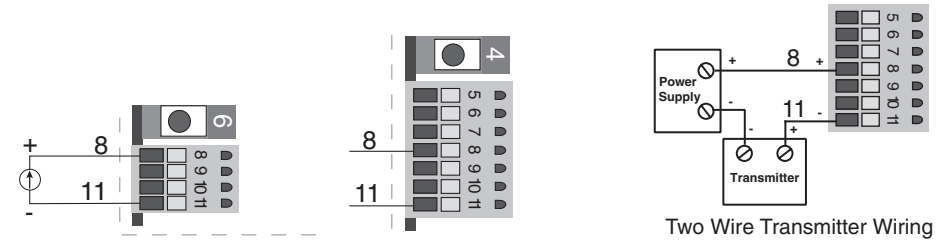

Figure 8b — Output 1 Mechanical Relay

SD31 - _ **J** _ _ _ _ _

- Form A contact
- 2 A, resistive
- 125 VA pilot duty, 120/240V~ (ac), inductive
- See Quencharc note
- 240V~ (ac) maximum
- 30V= (dc) maximum
- For use with ac or dc
- Minimum load current 10 mA
- Output does not supply power

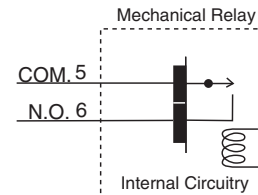
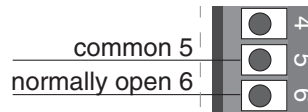
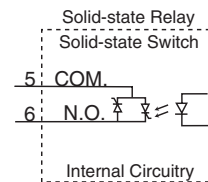
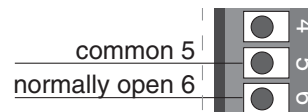

Figure 8c — Output 1 Solid-state Relay

SD31 - _ **K** _ _ _ _ _

- Form A contact
- 0.5 A maximum, resistive
- 20 VA pilot duty, 120/240V~ (ac), inductive
- See Quencharc note
- 24 to 240V~ (ac)
- Minimum load current 10 mA
- Maximum leakage current 100 μ A
- Not for use with direct current (dc)
- Output does not supply power





Warning:

Use National Electric (NEC) or other country-specific standard wiring and safety practices when wiring and connecting this controller to a power source and to electrical sensors or peripheral devices. Failure to do so may result in damage to equipment and property, and/or injury or loss of life.

Note: To prevent ground loops, isolation needs to be maintained from input to output when using switched DC or analog process outputs.

Quencharc Note:

Switching pilot duty inductive loads (relay coils, solenoids, etc.) with the mechanical relay or solid-state relay output options requires use of an R.C. suppressor.

Watlow carries the R.C. suppressor Quencharc brand name, which is a trademark of ITW Paktron. Watlow Part No. 0804-0147-0000.

Spring clamp wiring connector note:

To insert the wire, push the wire into the desired connection number, and it should automatically lock into place. To remove the wire, press and hold the orange release tab with a small screwdriver. Pull the wire out of the connection. Solid or tinned wire recommended.

Figure 9a — Output 1 Switched DC

SD31 - _ _ C _ _ _ _ _

- Supply current 30 mA \approx (dc) maximum
- Supply voltage 6 to 12V \approx (dc)
- Not recommended for switching mechanical relays
- Output supplies power

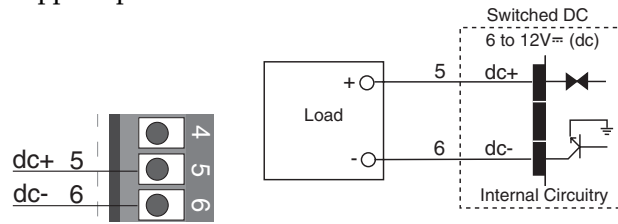

Figure 9b — Output 1 Process

SD31 - _ _ F _ _ _ _ _

- Analog output is scalable between 0 to 10V \approx (dc) or 0 to 20 mA \approx (dc)
- Load capability: voltage 1 k Ω minimum; current 800 Ω maximum
- Output supplies power
- Cannot use voltage and current output at the same time

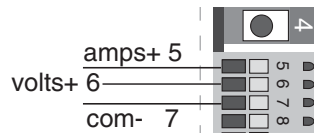
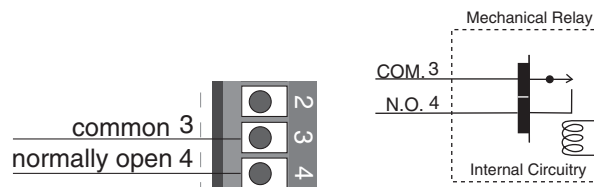

Figure 9c — Output 2 Mechanical Relay

SD31 - _ _ J _ _ _ _ _

- Form A contact
- 2 A, resistive
- 125 VA pilot duty, 120/240V \sim (ac), inductive
- See Quencharc note
- 240V \sim (ac) maximum
- 30V \approx (dc) maximum
- For use with ac or dc
- Minimum load current 10 mA
- Output does not supply power





Warning:

Use National Electric (NEC) or other country-specific standard wiring and safety practices when wiring and connecting this controller to a power source and to electrical sensors or peripheral devices. Failure to do so may result in damage to equipment and property, and/or injury or loss of life.

Quencharc Note:

Switching pilot duty inductive loads (relay coils, solenoids, etc.) with the mechanical relay or solid-state relay output options requires use of an R.C. suppressor.

Watlow carries the R.C. suppressor Quencharc brand name, which is a trademark of ITW Paktron. Watlow Part No. 0804-0147-0000.

Note: To prevent ground loops, isolation needs to be maintained from input to output when using switched DC or analog process outputs.

Figure 10a — Output 2 Solid-state Relay

SD31 - _ _ _ **K** _ - - - - -

- Form A contact
- 0.5 A maximum, resistive
- 20 VA pilot duty, 120/240V~ (ac), inductive
- See Quencharc note
- 24 to 240V~ (ac)
- Minimum load current 10 mA
- Maximum leakage current 100 μ A
- Not for use with direct current (dc)
- Output does not supply power

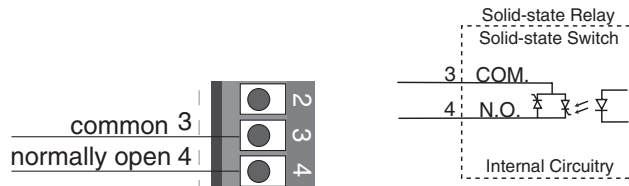

Figure 10b — Output 2 Switched DC

SD31 - _ _ _ **C** _ - - - - -

- Maximum supply current 30 mA \approx (dc)
- Supply voltage 6 to 12V \approx (dc)
- Not recommended for switching mechanical relays
- Output supplies power

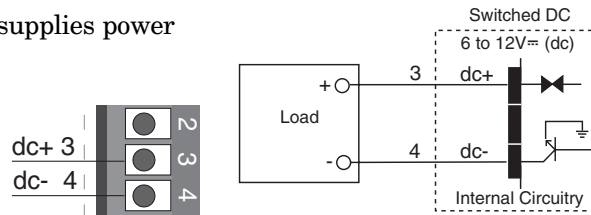
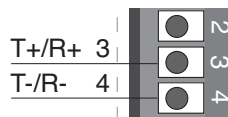

Figure 10c — Output 2 EIA/TIA-485

SD31 - _ _ _ **U** _ - - - - -

- Isolated [50 V \approx (dc)]
- Half duplex
- For more communications information, see the Features chapter



Selecting an EIA/TIA-232 to EIA/TIA-485 Converter

When choosing an EIA/TIA 232 to 485 converter, look for one with the following features:

Two-wire capability

EIA/TIA-485 can be implemented as a two-wire system or a four-wire system. Most Watlow controllers, including the Series SD31, use two-wire communications when working with EIA/TIA-485. The converter selected must have a two-wire mode. Some converters can only be used in a four-wire mode.

Automatic Send Data control

In a two-wire system, both the transmitted signals and the received signals travel over the same pair of wires, so the converter must have a method of changing from the transmit mode to the receive mode. Some converters require the toggling of a control line (usually the RTS line) to perform this transition, while others use an automatic timing circuit. The toggling method is dependent on the PC software to toggle the control line and the PC's operating system to make that transition happen in a timely manner. Because of these dependencies, the best choice for a converter is one with automatic control.

Isolation

Converters are available with or without input-to-output isolation. An isolated converter is not a requirement when used with the Series SD31, but it is recommended to avoid ground loops. Isolation could be a consideration when the Series SD31 will be used on a network with other devices that may require isolation.

Power Supply

Many converters can be powered up either through the signals of a serial port or through an external power supply. Because some computers, such as laptops, do not always provide enough power to supply the converter, we recommend using an external power supply with specifications as recommended by the converter manufacturer. Isolated converters may require two supplies.

Biasing and termination

If the system does not work properly, it may need termination resistors at each end of the network. A typical installation would require a 120-ohm resistor across the transmit/receive terminals (3 and 4) of the last controller in the network and the converter box. Pull-up and pull-down resistors may be needed at the converter to maintain the correct voltage during the idle state. The pull-up resistor is connected between the positive of the DC supply and the T+/R+ terminal. The pull-down resistor is connected between the negative of the DC supply and the T-/R- terminal.

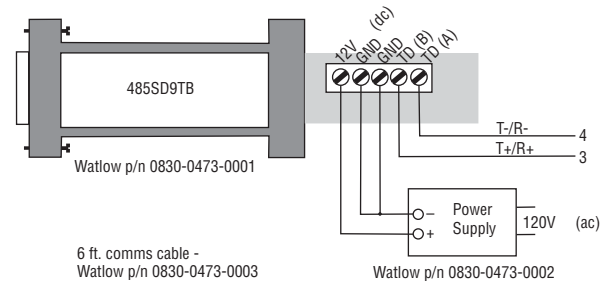

Figure 11a — B&B Converters
Isolated Converter - 485019TB
Non-Isolated Converter - 485S09TB
B&B Electronics Manufacturing Company,
(815) 433-5100, <http://www.bb-elec.com/>

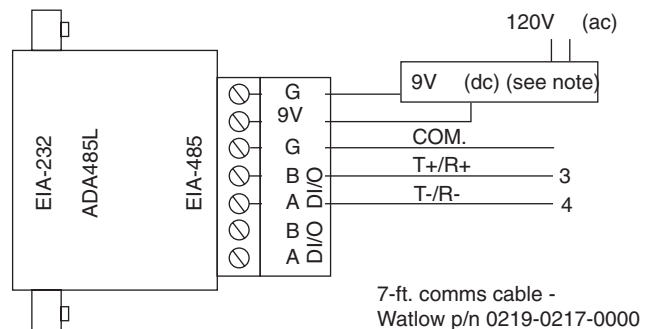

Figure 11b — CMC Non-Isolated Converter - ADA485L
CMC Connecticut Micro-Computer, Inc.,
1-800-426-2872, <http://www.2cmc.com/>

NOTE:

The CMC converter requires an external power supply when used with a laptop computer.

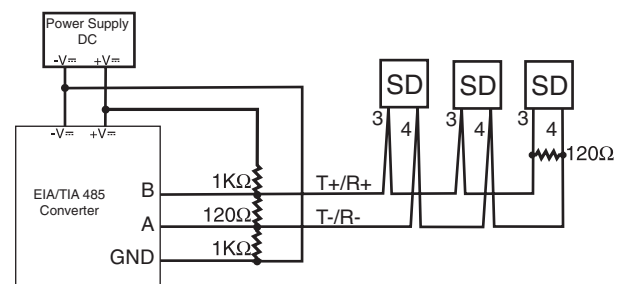

Figure 11c — Wiring bias and termination resistors.
Controllers must be wired in a daisy chain configuration.
Add a 120Ω termination resistor on the last controller.

Ethernet Gateway

The EM00-GATE-0000 is a bridge that allows up to 32 Watlow controllers to be directly connected to an Ethernet network.

The gateway provides a bridge for Modbus messages between the Ethernet bus and EIA-485 or EIA-232 links. The Gateway supports full product configuration monitoring and configuration of runtime parameters via MODBUS TCP over TCP/IP using a software package such as Watlow's WATVIEW™.

The Series SD31 can be configured using WATVIEW with or without the EM Gateway. Enhancements are planned for the EM Gateway.

For more information, go to www.watlow.com and search on *EM Gateway*.

Note: The 32 controller maximum is a functional limitation of Modbus.

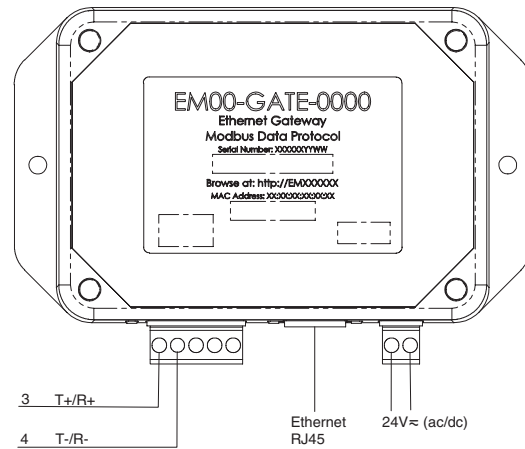

Figure 12a — Connecting to the Watlow EM Gateway (Ethernet to EIA/TIA 485 Serial Modbus connection). Controllers must be wired in a daisy chain configuration.

Note: UL Approved, Class 2, power supply required as EM Gateway power source: 24V~ (dc), part 0830-0474-000.

Notes:

3

Keys and Displays

Four Digit, LED Display:

- Indicates process value or set point information

or

- Page name, prompt name or prompt value, depending upon the key combination pressed.



Active Output Indicator Lights

Lit when the corresponding controller output or alarm is on.

Auto-Manual Control Indicator Light

On: Manual Mode (open-loop control)
Off: Auto Mode (closed-loop control)

Set Key

Press to view set point, process or parameter values, depending on *dSP* setting. Release **SET** Key to view page or parameter information.

Infinity Key

Returns to the Home Page.
Press and hold the Infinity Key **∞** for about 2 seconds to enter the Operations Page.
Clears latching alarms.

Up and Down Keys

On the Home Page, adjusts the set point (you may need to press and hold the **SET** Key depending on *dSP* setting).
On other pages, selects parameters, or allows changing parameter values when **SET** Key is pressed.

Note: After 60 seconds with no key presses, the controller reverts to the Home Page.

Home Page Overview

The Home Page is the default display of the Series SD31 controller. The Home Page can be configured to display either the process value or set point value. (see the *dSP* prompt on the Setup Page.) This parameter determines what parameters and values are displayed.

Automatic Mode % ○

The % indicator light is off.

* Actual temperature
Press **SET Key Set point value
(Use Up ▲ or Down ▼ keys to raise or lower the set point.)

Manual Mode % ●

The % indicator light is on.

* Actual temperature
Press **SET Key Output power setting (Use Up ▲ or Down ▼ keys to raise or lower the set point.)

Error condition % ●

The % indicator light is on. If the controller was in Auto mode it will switch to Manual mode when it detects an input error.

* Error message
Press **SET Key Output power setting (Use Up ▲ or Down ▼ keys to raise or lower the set point.)

Alarm Message

* -> Actual temperature
Press **SET Key -> Set point value
Alarm message alternates with set point or process value (auto mode) or power setting (manual mode).
The corresponding output indicator light is on.

During Ramping

The display alternates between the current set point achieved in the ramp, the actual process value and the target set point. The prompt appears in the display first and then the value for that prompt.

->->->->->

**Current	**Current	*Current	*Current	**Target	**Target
set point	set point	process	process	set point	set point
prompt	value	prompt	value	prompt	value

To change the target set point value, press and hold the **SET** Key and adjust the set point value using the UP ▲ or DOWN ▼ Keys.

Once the current set point reaches the target set point value, the ramp is complete and the display stops alternating.

* Appears if *dSP* = *Pro*. If *dSP* = *SEt*, press the **SET** Key to view this parameter.

** Appears if *dSP* = *Pro*. If *dSP* = *SEt*, you do not need to press the **SET** Key to view this parameter.

Adjusting the control set point

The controller must be in automatic mode. Adjust the control set point on the Home Page. It is not necessary to enter any other page. With $\boxed{dSP} = \boxed{Pro}$ (on Setup Page), the process temperature appears in the display. Press and hold the \boxed{SET} Key to display the control set point.

To adjust the set point:

1. Ensure the controller is in the automatic mode and that you are on the Home Page. If you are on any other page, press the Infinity Key ∞ .
2. The process temperature is displayed in the display window. Press and hold the \boxed{SET} Key, and use the Up Key \blacktriangle to increase the set point or press the Down Key \blacktriangledown to decrease the set point value.
3. The controller will automatically begin using the new set point after three seconds. or press the Infinity Key ∞ to immediately use the new value.

With $\boxed{dSP} = \boxed{SET}$ (on Setup Page), the control set point appears in the display, if the controller is in the automatic mode.

To adjust the set point:

1. Ensure the controller is in the automatic mode and that you are on the Home Page. If you are on any other page, press the Infinity Key ∞ .
2. The temperature set point is displayed in the display window. Press the Up Key \blacktriangle to increase the temperature. Press the Down Key \blacktriangledown to decrease the temperature.
3. The controller will automatically begin using the new set point after three seconds. or press the Infinity Key ∞ to immediately use the new value.

Note: The \boxed{LOC} parameter can lock the ability to adjust the set point. If you are unable to adjust the set point, check \boxed{LOC} setting on the Setup Page.



Caution:

The controller is in the manual mode when the percent LED % is lit. If the controller is in the manual mode, the manual output power value is displayed in place of the automatic mode control set point. Setting this value can force an output to stay on regardless of the temperature reading. Always ensure you are in the automatic mode when adjusting the temperature set point value.

Operations Page Overview

\boxed{OPER}

The Operations Page contains parameters accessed during normal day-to-day operation. The Series SD31 provides a patented user-definable menu system, allowing the user to customize the Operations Page contents.

To go to the Operations Page, press and hold the Infinity Key ∞ for about three seconds from the Home Page.

- Press the Down \blacktriangledown or Up \blacktriangle keys to move through the Operations Page parameters.
- To view or change a parameter value, press and hold the \boxed{SET} Key.
- Press the Down \blacktriangledown or Up \blacktriangle keys to change the parameter value.
- Press the Infinity Key ∞ at any time to return to the Home Page.

Operations Page (typical defaults)

\boxed{PohE}	Power Heat
$\boxed{A-MN}$	Auto-Manual
\boxed{AutE}	Autotune
\boxed{CAL}	Calibration Offset
\boxed{HECN}	Heat Control Method
\boxed{PbHE}	Proportional Band Heat
\boxed{rEHE}	Reset Heat OR
\boxed{IEHE}	Integral Heat
\boxed{rRHE}	Rate Heat OR
\boxed{dEHE}	Derivative Heat
\boxed{hhYS}	Heat Hysteresis
\boxed{CLCN}	Cool Control Method
\boxed{PbCL}	Proportional Band Cool
\boxed{rECL}	Reset Cool OR
\boxed{IECL}	Integral Cool
\boxed{rRCL}	Rate Cool OR
\boxed{dECL}	Derivative Cool
\boxed{ChYS}	Cool Hysteresis
$\boxed{A1H}$	Alarm 1 High
$\boxed{A1L}$	Alarm 1 Low
$\boxed{A2H}$	Alarm 2 High
$\boxed{A2L}$	Alarm 2 Low

Note: Hardware configuration and programming selections determine what parameters appear on the Operations Page. A maximum of 20 parameters can be defined on the Operations Page

Setup Page Overview

SEE

The Setup Page contains parameters that define basic controller functions. Go to the Setup Page for initial configuration or if your application requirements change. Be sure to program the Setup Page first!

Always press the Infinity Key ∞ to return to the Home Page.

You must start from the Home Page.

To go to the Setup Page, press both the Up \blacktriangle and Down \blacktriangledown keys for about three seconds.

- Press the Down \blacktriangledown or Up \blacktriangle keys to move through the Setup Page parameters.
- To view a parameter value, press and hold the **SET** Key.
- To change a parameter value, press and hold the **SET** Key and use the Down \blacktriangledown or Up \blacktriangle keys to change the parameter value.
- Press the Infinity Key ∞ at any time to return to the Home Page.

Note: Hardware configuration and programming selections determine what parameters appear on the Setup Page.

Setup Page

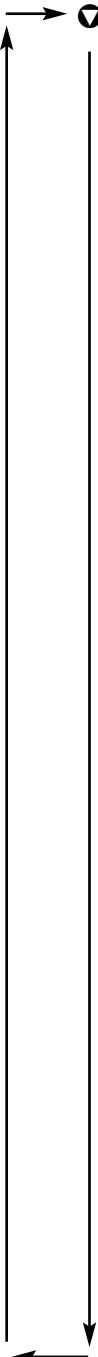

SEn	Sensor Type
LIn	Linearization
C-F	Temperature Units
SDEC	Temperature Decimal Places
PdEC	Process Decimal Places
ISEn	InfoSense Enable
ISP1	InfoSense Point 1
ISP2	InfoSense Point 2
ISP3	InfoSense Point 3
ISP4	InfoSense Point 4
ScLo	Process Scale Low
ScHi	Process Scale High
rSLo	Units Scale Low
rSHi	Units Scale High
SPLo	Set Point Low Limit
SPHi	Set Point High Limit
FErE	Enable Input Filter
FLEr	Filter Value
OE 1	Output 1 Type
CEr 1	Control Method 1
FEb 1	Fixed Time Base 1
PL 1	Power Limit 1
P5L 1	Output Power Scale Low 1
P5H 1	Output Power Scale High 1
nLF 1	Output Nonlinear Function 1
AO 1U	Analog Output 1 Units
OLo	Analog Output 1 Scale Low
OHi	Analog Output 1 Scale High
OE 2	Output 2 Function
CEr 2	Control Method 2
FEb 2	Fixed Time Base 2
PL 2	Power Limit 2
P5L 2	Output Power Scale Low 2
P5H 2	Output Power Scale High 2
nLF 2	Output Nonlinear Function 2
hYS 1	Alarm 1 Hysteresis
L9c 1	Alarm 1 Logic
LRE 1	Alarm 1 Latching
Sil 1	Alarm 1 Silencing
dSP 1	Alarm 1 Message
hYS 2	Alarm 2 Hysteresis
L9c 2	Alarm 2 Logic
LRE 2	Alarm 2 Latching
Sil 2	Alarm 2 Silencing
dSP 2	Alarm 2 Message
ACLF	AC Line Frequency
Unit	Units of Measurement
IErr	Input Error Latching
FRIL	Input Error Failure Mode
P9Rn	Input Error Power
dSP	Active Displays
rP	Ramp to Set Point Mode
rPSc	Ramp Scale
rPrE	Ramp Rate
Addr	Modbus Device Address
bRud	Baud Rate
LOC	Lockout

Programming Page Overview Prog

The Programming Page determines what parameters the user wants to appear on the Operations Page. Select a parameter for any of the 20 Programming Page locations, P1 to P20. These now appear on the Operations Page. All 20 locations have parameters selected as defaults.

To go to the Programming Page, hold down the Infinity key ∞ , then press the SET Key **SET**, and hold both down for about six seconds.

- Press the Down \blacktriangledown or Up \blacktriangle keys to move through the Programming Page parameters, P1-P20.
- To view a parameter value, press and hold the **SET** Key.
- To change a parameter value, press and hold the **SET** Key and use the Down \blacktriangledown or Up \blacktriangle keys to change the parameter value.
- Press the Infinity Key ∞ at any time to return to the Home Page.

Note: The hardware configuration and programming selections will also determine what parameters appear on the Operations Page. A Programming Page selection will not appear on the Operations Page if the parameter is not active.

Programming Page

<div style="border: 1px solid black; padding: 2px; width: fit-content;">nonE</div> <div style="border: 1px solid black; padding: 2px; width: fit-content;">* P1</div> <div style="border: 1px solid black; padding: 2px; width: fit-content;">(48)*</div> <div style="border: 1px solid black; padding: 2px; width: fit-content;">P20</div> <div style="border: 1px solid black; padding: 2px; width: fit-content;">(67)*</div>	\blacktriangledown \blacktriangle	<p>nonE (0) None</p> <p>CRl (1) Calibration Offset</p> <p>C-F (2) Temperature Units (Setup Page)</p> <p>AlLo (3) Alarm 1 Low</p> <p>AlHi (4) Alarm 1 High</p> <p>AlLo (5) Alarm 2 Low</p> <p>AlHi (6) Alarm 2 High</p> <p>hYS1 (9) Alarm Hysteresis 1 (Setup Page)</p> <p>hYS2 (10) Alarm Hysteresis 2 (Setup Page)</p> <p>Addr (12) Modbus Device Address (Setup Page)</p> <p>AutE (13) Autotune</p> <p>A-M (14) Auto-Manual</p> <p>Power (15) Power Heat</p> <p>Power (16) Power Cool</p> <p>CRh (17) Heat Control Method</p> <p>PbHE (18) Proportional Band Heat</p> <p>IEHE (19) Integral Heat OR</p> <p>REHE (19) Reset Heat</p> <p>DEHE (20) Derivative Heat OR</p> <p>REHE (20) Rate Heat</p> <p>dbHE (21) Dead Band Heat</p> <p>hHYS (22) Heat Hysteresis</p> <p>CRCL (23) Cool Control Method</p> <p>PbCL (24) Proportional Band Cool</p> <p>IECL (25) Integral Cool OR</p> <p>RECL (25) Reset Cool</p> <p>DECL (26) Derivative Cool OR</p> <p>RECL (26) Rate Cool</p> <p>dbCL (27) Dead Band Cool</p> <p>CHYS (28) Cool Hysteresis</p> <p>PrOP (29) Proportional Term</p> <p>IE (30) Integral Term</p> <p>dE (31) Derivative Term</p> <p>rPrE (32) Ramp Rate (Setup Page)</p>
---	--	---

*Programming Page parameters Modbus register numbers P1 through P20 are 48 through 67

Factory Page Overview Fact

The Factory Page contains information on diagnostics, calibration and restore-parameter functions.

To go to the Factory Page, press both the Up \blacktriangle and Down \blacktriangledown keys for about six seconds from the Home Page.

- Press the Down \blacktriangledown or Up \blacktriangle keys to move through the Factory Page parameters.
- To view a parameter value, press and hold the **SET** Key.
- To change a parameter value, press and hold the **SET** Key and use the Down \blacktriangledown or Up \blacktriangle keys to change the parameter value.
- Press the Infinity Key ∞ at any time to return to the Home Page.

Note: Hardware configuration and programming selections determine what parameters appear on the Factory Page.

Factory Page

\blacktriangledown \blacktriangle	<p>RTAb Ambient Temperature</p> <p>RTAn Minimum Recorded Ambient Temperature</p> <p>RTAr Maximum Recorded Ambient Temperature</p> <p>dSPi Display Intensity</p> <p>ROE1 Output 1 Process Value</p> <p>rESE Restore Factory Calibration</p> <p>USrR Restore User Settings</p> <p>USrS Save User Settings</p> <p>dFLt Default Parameters</p> <p>OEY1 Output 1 Type</p> <p>OEY2 Output 2 Type</p> <p>SId Software ID</p> <p>SUEr Software Version</p> <p>SbLd Software Build Number</p> <p>PUDr Power Type</p> <p>Snr Serial Number 1 (first four digits)</p> <p>Snr Serial Number 2 (last four digits)</p> <p>tc50 Thermocouple, 50mV</p> <p>tc00 Thermocouple, 0mV</p> <p>tc32 Thermocouple, 32°F</p> <p>r15 RTD, 15 ohm</p> <p>r380 RTD, 380 ohm</p> <p>U1 Input Calibrate, 1.0 Volt</p> <p>U9 Input Calibrate, 9.0 Volt</p> <p>A4 Input Calibrate, 4.0 mA</p> <p>A16 Input Calibrate, 16.0 mA</p> <p>O11v Output 1 Calibrate, 1.0 Volt</p> <p>O19v Output 1 Calibrate, 9.0 Volt</p> <p>O14A Output 1 Calibrate, 4.0 mA</p> <p>O116 Output 1 Calibrate, 16.0 mA</p>
--	---

4

Home Page

Press the Infinity Key  at any time to go to the Home Page.

Depending upon the controller's status, you will see some combination of the parameters listed below. Normally, you will see the Process Value in the display. See Home Page Overview in Chapter Three.

After 60 seconds with no key presses, the controller reverts to the Home Page.

Display	Parameter Name Description	Settings	Range (Integer values for Modbus in parenthesis.)	Default	Modbus* (less 40,001 offset) Read/Write	Appears if:
Measured Value	Process Value Displays the current process value.		-1999 to 9999 degrees or units (-1999000 to 9999000)	NA	*20, 21 R	There is no input error and [FErrE] is set to [OFF] or [Cont] .
Set Value	Closed Loop Set Point Show the current closed loop control set point.		Set Point Low Limit [SPLo] to Set Point High Limit [SPHi]	75	*27, 28 R/W	Control mode is [Auto] and there is no input error.
Measured Value	Filtered Process Value Displays the current filtered process value.		-1999 to 9999 degrees or units (-1999000 to 9999000)	NA	*22, 23 R	There is no input error and [FErrE] is set to [dSP] or [both] .
Set Value	Open Loop Output Power Show the current open loop (manual) control set point. The % indicator light is on when the controller is in open loop (manual control).		-100.0 to 0.0% if any output is set to cool; 0.0 to 100.0% if any output is set to heat (-10000 to 0000, 0000 to 10000. Two decimal places implied for Modbus.)	0.0%	26 R/W	Control mode is [MAN] . If there is no input error and [FErrE] is set to [OFF] or [Cont] .
[rP]	Current Ramp Set Point The current working control set point for the ramp that is in process appears in the display after this prompt appears.		-1999 to 9999 (-1999000 to 9999000)	NA	*254 255 R	Controller is ramping.
[Proc]	Process Value Displays the current process value.		-1999 to 9999 degrees or units (-1999000 to 9999000)	NA	*20, 21 R	If there is no input error, ramping set point is active and [dSP] is set to [Proc] .
[rPtg]	Ramp Target Set Point The target set point for the ramp that is in process appears in the display after this prompt appears.		Set Point Low Limit [SPLo] to Set Point High Limit [SPHi]	NA	Same as Closed Loop Set Point	Controller is ramping.
[ErrIn]	Input Error Indicate an input error state.		None (0) [--- Error (1)	NA	24 R	There is an analog input error.
[AlLo]	Alarm Low 1 Status Indicate a low alarm at output 1.		None (0) Alarm (1)	NA	29 R	There is an Alarm 1 low side alarm.
[AlHi]	Alarm High 1 Status Indicate a high alarm at output 1.		None (0) Alarm (1)	NA	30 R	There is an Alarm 1 high side alarm.
[Al2Lo]	Alarm Low 2 Status Indicate a low alarm at output 2.		None (0) Alarm (1)	NA	31 R	There is an Alarm 2 low side alarm.
[Al2Hi]	Alarm High 2 Status Indicate a high alarm at output 2.		None (0) Alarm (1)	NA	32 R	There is an Alarm 2 high side alarm.

Note: Some values will be rounded off to fit in the four-character display. Full values can be read with Modbus.



* Low register numbers contain the two higher bytes; high register numbers contain the two lower bytes of the four-byte integer. Decimal precision is implied at three decimal places unless otherwise noted.

Caution: Writing to registers continuously, such as ramping set points via comms, will damage the SD31 EEPROM memory. See page 47.





Note: The **[dSP]** setting on the Setup Page, determines if Process or Set Point is normally displayed and the action of the **[SET]** Key.

5

Setup Page

To go to the Setup Page, press both the Down  and Up  keys for three seconds from the Home Page.

SEt will appear in the display.

- Press the Down  or Up  keys to move through the Setup Page parameters.
- To view or change a parameter value, press and hold the **SEt** Key.
- Press the Down  or Up  keys to change the parameter value.
- Press the Infinity Key  at any time to return to the Home Page.

Display	Parameter Name Description	Settings	Range (Integer values for Modbus in parentheses.)	Default	Modbus* (less 40,001 offset) Read/Write	Appears if:
SEn [SEn]	Sensor Type Set the analog sensor type.		tc (0) rtd (1) rtd (2) volt (3)	tc (0)	70 R/W	Always active.
Lin [Lin]	Thermocouple Linearization Set the analog input thermocouple linearization.		J (0) d (6) H (1) PT11 (7) E (2) r (8) S (3) S (9) n (4) b (10) C (5)	J (0)	71 R/W	SEn is set to tc .
C-F [C-F]	Temperature Units Set the temperature units for thermocouple and RTD inputs.		F Fahrenheit (0) C Celsius (1)	F (0)	40 R/W	SEn is set to tc or rtd .
SdEC [S.dEC]	Temperature Decimal Places Set the decimal places for the displayed input value for thermocouple and RTD types.		0 (0) 00 (1)	0 (0)	41 R/W	SEn is set to tc or rtd .
PdEC [P.dEC]	Process Decimal Places Set the decimal places for the displayed input value for process types.		0 (0) 00 (1) 000 (2) 0000 (3)	0 (0)	42 R/W	SEn is set to rtd or volt .
ISEn [IS.En]	INFOSENSE™ Enable the sensor feature, which synchronizes the controller with a Watlow sensor.		no (0) YES (1)	no (0)	91 R/W	Always active.
ISP1 [IS.P1]	INFOSENSE™ 1 Set sensor point 1 code.		0 to 999 (0 to 999)	500	92 R/W	ISEn is set to YES .
ISP2 [IS.P2]	INFOSENSE™ 2 Set sensor point 2 code.		0 to 999 (0 to 999)	500	93 R/W	ISEn is set to YES .
ISP3 [IS.P3]	INFOSENSE™ 3 Set sensor point 3 code.		0 to 999 (0 to 999)	500	94 R/W	ISEn is set to YES .
ISP4 [IS.P4]	INFOSENSE™ 4 Set sensor point 4 code.		0 to 999 (0 to 999)	500	95 R/W	ISEn is set to YES .

Note: Some values will be rounded off to fit in the four-character display. Full values can be read with Modbus.

* Low register numbers contain the two higher bytes; high register numbers contain the two lower bytes of the four-byte integer. Decimal precision is implied at three decimal places unless otherwise noted.

Caution: Writing to registers continuously, such as ramping set points via comms, will damage the SD31 EEPROM memory. See page 47.

Display	Parameter Name Description	Settings	Range (Integer values for Modbus in parentheses.)	Default	Modbus* (less 40,001 offset) Read/Write	Appears if:
ScLo [Sc.Lo]	Process Scale Low Set the low scale for process inputs.		0.00 to 20.00 mA: if SEn is set to PnA (0000 to 20000) 0.00 to 10.00V: if SEn is set to uOLt (0000 to 10000)	4.00 mA 0.00V	*73, 74 R/W (mA) *77, 78 R/W (V)	SEn is set to PnA or uOLt .
ScHi [Sc.hi]	Process Scale High Set the high scale for process inputs.		0.00 to 20.00 mA: if SEn is set to PnA (0000 to 20000) 0.00 to 10.00V: if SEn is set to uOLt (0000 to 10000)	20.00 mA 5.00V	*75, 76 R/W (mA) *79, 80 R/W (V)	SEn is set to PnA or uOLt .
rgLo [rg.Lo]	Units Scale Low Set the low range for process input units.		-1999 to 9999 (-1999000 to 9999000) (Set precision with PdEC , Process Decimal Places.)	-1999	*81, 82 R/W	SEn is set to PnA or uOLt .
rgHi [rg.hi]	Units Scale High Set the high range for process input units.		-1999 to 9999 (-1999000 to 9999000) (Set precision with PdEC , Process Decimal Places.)	9999	*83, 84 R/W	SEn is set to PnA or uOLt .
SPLo [SP.Lo]	Set Point Low Limit Set the low range for the set point.		Min. operating range (of sensor) to SPHi -0.100: if SEn is set to tc -328 to SPHi -0.100: if SEn is set to rtD -1999 to SPHi -0.001: if SEn is set to PnA or uOLt (Set precision with PdEC , Process Decimal Places.)	Min. operat- ing range (J type): tc -328: rtD -999: PnA and uOLt .	*240, 241 R/W (ther- mocouple) *244, 245 R/W (RTD) *248, 249 R/W (mA or V)	Always active.
SPHi [SP.hi]	Set Point High Limit Set the high range for the set point.		rgLo to max. operating range (of sensor): if SEn is set to tc SPLo +0.100 to 1472: if SEn is set to rtD SPLo +0.001 to 9999: if SEn is set to PnA or uOLt (Set precision with PdEC , Process Decimal Places)	Max. operat- ing range (J type): tc 1472: rtD 999: PnA and uOLt .	*242, 243 R/W (ther- mocouple) *246, 247 R/W (RTD) *250, 251 R/W (mA or V)	Always active.
FtrE [Ftr.E]	Input Filter Select filtering action.		OFF (0) (no filtering) dISP (1) (filter only the display value) ConE (2) (filter the control input values) both (3)	OFF (0)	89 R/W	Always active.
FLtr [FLtr]	Filter Value Set the input filter value.		0.0 to 60.0 seconds (0000 to 60000)	0.0	*87, 88 R/W	FtrE is not set to OFF .
Ot 1 [Ot 1]	Output 1 Function Set Output 1 function.		OFF Off (0) PnAL Process Alarm (1) dEAL Deviation Alarm (2) HEAL Heat Control (3) COOL Cool Control (4)	HEAL (3)	143 R/W	Always active.

Note: Some values will be rounded off to fit in the four-character display. Full values can be read with Modbus.

* Low register numbers contain the two higher bytes; high register numbers contain the two lower bytes of the four-byte integer. Decimal precision is implied at three decimal places unless otherwise noted.

Caution: Writing to registers continuously, such as ramping set points via comms, will damage the SD31 EEPROM memory. See page 47.

Display	Parameter Name Description	Settings	Range (Integer values for Modbus in parentheses.)	Default	Modbus* (less 40,001 offset) Read/Write	Appears if:
[Ctr1] [Ctr1]	Control Method 1 Set output 1 control type. This parameter is only used with PID control, but can be set anytime.		[Ftb] Fixed Time Base (0) [UrTb] Variable Time Base (1)	[Ftb] (0)	144 R/W	[DE 1] is set to [hERE] or [CoOL] and output type is SD _ _ _ C _ _ _ or SD _ _ _ K _ _ _ .
[Ftb1] [Ftb1]	Fixed Time Base 1 (Cycle Time) Set the time base for Fixed Time Base Control.		1.0 to 60.0 seconds if Output 1 is a mechanical relay (1000 to 60000) 0.1 to 60.0 seconds if Output 1 is not a mechanical relay (100 to 60000)	20.0: mech. relay 5.0: solid-state relay 1.0: switched dc	*145, 146 R/W	[DE 1] is set to [hERE] or [CoOL] , [Ctr 1] is set to [Ftb] and Output 1 is not a process output. (not SD _ _ _ F _ _ _)
[PL 1] [PL 1]	Power Limit 1 Set the maximum power output for a control output		0.0 to 100.0% power (000 to 10000) (Two decimal places implied for Modbus.)	100.0%	160 R/W	[DE 1] is set to [hERE] or [CoOL] .
[PSL1] [PSL1]	Output Power Scale Low 1 Set the low end of the range within which the output will scale.		0.0 to 100.0% (000 to 10000) (Two decimal places implied for Modbus.)	0%	161 R/W	[DE 1] is set to [hERE] or [CoOL] , [Ctr 1] is set to [Ftb] and Output 1 is not a process output. (not SD _ _ _ F _ _ _)
[PSH1] [PSH1]	Output Power Scale High 1 Set the high end of the range within which the output will scale.		0.0 to 100.0% (000 to 10000) (Two decimal places implied for Modbus.)	100%	162 R/W	[DE 1] is set to [hERE] or [CoOL] , [Ctr 1] is set to [Ftb] and Output 1 is not a process output. (not SD _ _ _ F _ _ _)
[nLF1] [nLF1]	Output Nonlinear Function 1 Select a nonlinear output curve to match the response of your system.		[OFF] Off (0) [CrV1] curve 1 (1) [CrV2] curve 2 (2)	[OFF] (0)	163 R/W	[DE 1] is set to [hERE] or [CoOL] .
[AO1.U] [AO1.U]	Analog Output 1 Units Set the analog output units.		[mA] milliamperes (0) [VOLT] volts (1)	[mA] (0)	147 R/W	Output 1 is a process output. (SD _ _ _ F _ _ _)
[O1.Lo] [O1.Lo]	Analog Output 1 Scale Low Set the low scale for the process output.		0.00 to 20.00 mA if output is set to mA (0000 to 20000) 0.00 to 10.00V if output is set to volts (0000 to 10000)	4.00 mA 0.00V	*148, 149 R/W (mA) *152, 153 R/W (V)	Output 1 is a process output. (SD _ _ _ F _ _ _)
[O1.hi] [O1.hi]	Analog Output 1 Scale High Set the high scale for the process output.		0.00 to 20.00 mA if output is set to mA (0000 to 20000) 0.00 to 10.00V if output is set to volts (0000 to 10000)	20.00 mA 10.00V	*150, 151 R/W (mA) *154, 155 R/W (V)	Output 1 is a process output. (SD _ _ _ F _ _ _)
[Ot2] [Ot2]	Output 2 Function Set Output 2 function.		[OFF] Off (0) [PrAL] Process Alarm (1) [dEAL] Deviation Alarm (2) [hERE] Heat Control (3) [CoOL] Cool Control (4)	[OFF] (0)	167 R/W	Output 2 is installed and is not a communications output.
[Ctr2] [Ctr2]	Control Method 2 Set Output 2 control type. This parameter is only used with PID control, but can be set anytime.		[Ftb] Fixed Time Base (0) [UrTb] Variable Time Base (1)	[Ftb] (0)	168 R/W	[DE 2] is set to [hERE] or [CoOL] and output type is SD _ _ _ C _ _ _ or SD _ _ _ K _ _ _ .

Note: Some values will be rounded off to fit in the four-character display. Full values can be read with Modbus.

* Low register numbers contain the two higher bytes; high register numbers contain the two lower bytes of the four-byte integer. Decimal precision is implied at three decimal places unless otherwise noted.

Caution: Writing to registers continuously, such as ramping set points via comms, will damage the SD31 EEPROM memory. See page 47.

Display	Parameter Name Description	Settings	Range (Integer values for Modbus in parentheses.)	Default	Modbus* (less 40,001 offset) Read/Write	Appears if:
[Ftb2] [Ftb2]	Fixed Time Base 2 (Cycle Time) Set the time base for Fixed Time Base Control.		1.0 to 60.0 seconds if Output 2 is mechanical relay (1000 to 60000) 0.1 to 60.0 seconds if Output 2 is not a mechanical relay (100 to 60000)	20.0: mech. relay 5.0: solid-state relay 1.0: switched dc	*169, 170 R/W	[DE 2] is set to [HEAT] or [COOL] , and [Err2] is [Ftb] .
[PL 2] [PL2]	Power Limit 2 Set maximum power output for a control output.		0.0 to 100.0% power (000 to 10000) (Two decimal places implied for Modbus.)	100.0%	171 R/W	[DE 2] is set to [HEAT] or [COOL] .
[PSL2] [PSL2]	Output Power Scale Low 2 Set the low end of the range within which the output will scale.		0.0 to 100.0% (000 to 10000) (Two decimal places implied for Modbus.)	0%	172 R/W	[DE 2] is set to [HEAT] or [COOL] , [Err2] is set to [Ftb] and Output 2 is not a communications output. (not SD_ _ _ _ U _ _ _ _)
[PSH2] [PSH2]	Output Power Scale High 2 Set the high end of the range within which the output will scale.		0.0 to 100.0% (000 to 10000) (Two decimal places implied for Modbus.)	100.0%	173 R/W	[DE 2] is set to [HEAT] or [COOL] , [Err2] is set to [Ftb] and Output 2 is not a communications output. (not SD_ _ _ _ U _ _ _ _)
[nLF2] [nLF2]	Output Nonlinear Function 2 Select a nonlinear output curve to match the response of your system.		[OFF] Off (0) [CrV1] curve 1 (1) [CrV2] curve 2 (2)	[OFF] (0)	174 R/W	[DE 2] is set to [HEAT] or [COOL] .
[hYS1] [hyS1]	Alarm 1 Hysteresis Set the hysteresis for an alarm. This determines how far into the safe region the input needs to move before the alarm can be cleared.		0.0 to 999.0 (0000 to 999000)	1.0	*106, 107 R/W	[DE 1] is set to [dEAL] or [PrAL] .
[Lgc1] [Lgc1]	Alarm 1 Logic Select the alarm output condition in the alarm state.		[AL C] closed on alarm (0) [AL O] open on alarm (1)	[AL C] (0)	164 R/W	[DE 1] is set to [dEAL] or [PrAL] .
[LAt1] [LAt1]	Alarm 1 Latching Turn alarm latching on or off.		[nLAt] off (0) [LAt] on (1)	[nLAt] (0)	108 R/W	[DE 1] is set to [dEAL] or [PrAL] .
[SiL1] [SiL1]	Alarm 1 Silencing Turn alarm silencing on or off.		[OFF] off (0) no silencing [On] on (1) silencing	[OFF] (0)	109 R/W	[DE 1] is set to [dEAL] or [PrAL] .
[dSP1] [dSP1]	Alarm 1 Message Displays an alarm message when an alarm is active.		[OFF] off (0) no message [On] on (1) message	[On] (1)	110 R/W	[DE 1] is set to [dEAL] or [PrAL] .
[hyS2] [hyS2]	Alarm 2 Hysteresis Set the hysteresis for an alarm. This determines how far into the safe region the input needs to move before the alarm can be cleared.		0.0 to 999.0 (0000 to 999000)	1.0	*121, 122 R/W	[DE 2] is set to [dEAL] or [PrAL] .

Note: Some values will be rounded off to fit in the four-character display. Full values can be read with Modbus.

* Low register numbers contain the two higher bytes; high register numbers contain the two lower bytes of the four-byte integer. Decimal precision is implied at three decimal places unless otherwise noted.

Caution: Writing to registers continuously, such as ramping set points via comms, will damage the SD31 EEPROM memory. See page 47.

Display	Parameter Name Description	Settings	Range (Integer values for Modbus in parentheses.)	Default	Modbus* (less 40,001 offset) Read/Write	Appears if:
[Lgc2] [Lgc2]	Alarm 2 Logic Select the alarm output condition in the alarm state.		[AL C] closed on alarm (0) [AL O] open on alarm (1)	[AL C] (0)	175 R/W	[DE 2] is set to [dEAL] or [PrAL] .
[LAE2] [LAt2]	Alarm 2 Latching Turn alarm latching on or off.		[nLAE] off (0) [LAE] on (1)	[nLAE] (0)	123 R/W	[DE 2] is set to [dEAL] or [PrAL] .
[SiL2] [SiL2]	Alarm 2 Silencing Turn alarm silencing on or off.		[OFF] off (0) no silencing [On] on (1) silencing	[OFF] (0)	124 R/W	[DE 2] is set to [dEAL] or [PrAL] .
[dSP2] [dSP2]	Alarm 2 Message Displays an alarm message when an alarm is active.		[OFF] off (0) no message [On] on (1) message	[On] (1)	125 R/W	[DE 2] is set to [dEAL] or [PrAL] .
[ACLF] [Unit]	AC Line Frequency Set the frequency of the applied AC line power source.		[50] 50 (0) [60] 60 (1)	[60] (1)	276 R/W	If [Err 1] or [Err 2] is set to [UrEb] .
[Unit] [Unit]	Units of Measurement Set the type of units used for the PID control parameters.		[US] US (0) [SI] SI (1)	[US] (0)	45 R/W	Always active.
[LErr] [LErr]	Input Error Latching Turn input error latching on or off.		[nLAE] off (0) [LAE] on (1)	[nLAE] (0)	90 R/W	Always active.
[FAIL] [FAIL]	Input Error Failure Mode Set the input error failure mode when an error is detected and the control changes to manual mode.		[OFF] off (0) (0% power) [bPLS] bumpless (1) (current power level) [mAn] manual (2) (fixed power level)	[bPLS] (1)	252 R/W	Always active.
[MAn] [MAn]	Input Error Power Set the manual power level when an input error causes a change to manual mode.		-100.0 to 100.0% (-10000 to 10000)	0.0%	253 R/W	[FAIL] is set to [mAn] .
[dSP] [dSP]	Display Default Select which display appears normally and which display requires pressing the [SET] Key to access.		[SEt] set point normally appears, press [SET] Key to view process value (1) [Pro] process normally appears, press [SET] Key to view set point value (2)	[Pro] (2)	44 R/W	Always active.
[rP] [rP]	Ramping Mode Select when the control set point ramps to the defined end set point.		[OFF] off (0) [SEr] ramps on start-up only (1) [On] ramps at start-up or any set point change (2)	[OFF] (0)	266 R/W	Always active.
[rPSc] [rPSc]	Ramp Scale Select the scale of the ramp rate.		[hour] degrees/hour (0) [min] degrees/minute (1)	[hour] (0)	267 R/W	[rP] is set to [SEr] or [On] .

Note: Some values will be rounded off to fit in the four-character display. Full values can be read with Modbus.

* Low register numbers contain the two higher bytes; high register numbers contain the two lower bytes of the four-byte integer. Decimal precision is implied at three decimal places unless otherwise noted.

Caution: Writing to registers continuously, such as ramping set points via comms, will damage the SD31 EEPROM memory. See page 47.

Display	Parameter Name Description	Settings	Range (Integer values for Modbus in parentheses.)	Default	Modbus* (less 40,001 offset) Read/Write	Appears if:
rPrt [rP.rt]	Ramp Rate Set the rate for the set point ramp.		0 to 9999 (0000 to 9999000)	100	*268, 269 R/W	rP is set to SEr or On . Does not appear if rP is set to OFF .
Addr [Addr]	Modbus Device Address Set the device address for communica- tions. Every controller on a network must have a unique address.		1 to 247	1	This can only be set from the controller front panel.	Output 2 is a communi- cations output. (SD_ _ _ _ U _ _ _ _)
bAud [bAud]	Baud Rate Set the baud rate at which the communi- cations occurs.	9600 192 384		9600	This can only be set from the controller front panel.	Output 2 is a communi- cations output. (SD_ _ _ _ U _ _ _ _)
LOC [LOC]	Lockout Set the security level for the user inter- face.	0 (0) no lockout 1 (1) Set Point, Auto/Manual, alarms only 2 (2) Set Point, Auto/Manual, only 3 (3) Set Point only 4 (4) full lockout See the Features Chapter for details.		0 (0)	43 R/W	Always active.

Note: Some values will be rounded off to fit in the four-character display. Full values can be read with Modbus.

* Low register numbers contain the two higher bytes; high register numbers contain the two lower bytes of the four-byte integer. Decimal precision is implied at three decimal places unless otherwise noted.

Caution: Writing to registers continuously, such as ramping set points via comms, will damage the SD31 EEPROM memory. See page 47.

Notes:

6

Operations Parameters Table

These parameters can be selected to appear on the Operations Page. Select parameters to appear on the Operations Page on the Programming Page.

To go to the Operations Page, press and hold the Infinity Key ∞ for three seconds from the Home Page.

OPER will appear in the display.

- Press the Down \blacktriangledown or Up \blacktriangle keys to move through the Operations Page parameters.
- To view or change a parameter value, press and hold the **SET** Key.
- Press the Down \blacktriangledown or Up \blacktriangle keys to change the parameter value.
- Press the Infinity Key ∞ at any time to return to the Home Page.

Display	Parameter Name Description	Settings	Range (Integer values for Modbus in parentheses.)	Default	Modbus* (less 40,001 offset) Read/Write	Appears if:
Po.ht [Po.ht]	Power Heat Displays the current heat control power.		0.0 to 100.0% power (000 to 10000) (Two decimal places implied for Modbus.)	NA	256 R	A-M is set to AUTO and at least one output is set to HEAT .
Po.CL [Po.CL]	Power Cool Displays the current cool control power.		0.0 to 100.0% power (000 to 10000) (Two decimal places implied for Modbus.)	NA	257 R	A-M is set to AUTO and at least one output is set to COOL .
A-M [A-M]	Auto-Manual Mode Set the control mode.	AUTO (0) MAN (1)		AUTO (0)	25 R/W	Always appears.
Aut [Aut]	Autotune Start an autotune.	OFF off (0) On on (1)		OFF (0)	215 R/W	At least one output is set to HEAT or COOL .
CAL [CAL]	Calibration Offset Offset the input reading.		-999 to 999 (-999000 to 999000)	0.0	*85, 86 R/W	Always appears.
ht.M [ht.M]	Heat Control Method Set the heat control method.	OFF off (0) PID PID (1) on-off on-off (2)		PID (1)	213 R/W	At least one output is set to HEAT .
Pb.ht [Pb.ht]	Proportional Band Heat Set the proportional band for the heat outputs.		1 to 999°F, if SEN is set to tc or rtd (1000 to 999000) 0.000 to 999 units, if SEN is set to RA or wolt . (0000 to 999000)	25 25	*216, 217 R/W *220, 221 R/W	At least one output is set to HEAT and HEAT is set to PID .
rE.ht [rE.ht]	Reset Heat Set the PID reset in repeats per minute for the heat outputs.		0.00 to 99.99 repeats per minute (0000 to 99990) 0.00: disabled	0.00	*224, 225 R/W (Modbus value is in- tegral, which is the inverse of reset.)	At least one output is set to HEAT , HEAT is set to PID , and Unit is set to US .
It.ht [It.ht]	Integral Heat Set the PID integral in minutes per re- peat for the heat outputs.		0.00 to 99.99 minutes/per repeat (0000 to 99990) 0.00: disabled	0.00	*224, 225 R/W	At least one output is set to HEAT , HEAT is set to PID , and Unit is set to SI .

Note: Parameters appear on the Operations Page only if activated from the Programming Page. See page 21 for Operations Page defaults.

Note: Some values will be rounded off to fit in the four-character display. Full values can be read with Modbus.

* Low register numbers contain the two higher bytes; high register numbers contain the two lower bytes of the four-byte integer. Decimal precision is implied at three decimal places unless otherwise noted.

Caution: Writing to registers continuously, such as ramping set points via comms, will damage the SD31 EEPROM memory. See page 47.

Display	Parameter Name Description	Settings	Range (Integer values for Modbus in parentheses.)	Default	Modbus* (less 40,001 offset) Read/Write	Appears if:
rAht [rA.ht]	Rate Heat Set the PID rate time in minutes for the heat output.		0.00 to 9.99 minutes (0000 to 9990) 0.00: disabled	0.00	*228, 229 R/W	At least one output is set to HEAT , HEAT is set to PID , and Unit is set to US .
dEht [dE.ht]	Derivative Heat Set the PID derivative time in minutes for the heat outputs.		0.00 to 9.99 minutes (0000 to 9990) 0.00: disabled	0.00	*228, 229 R/W	At least one output is set to HEAT , HEAT is set to PID , and Unit is set to SI .
dbht [dB.ht]	Dead Band Heat An offset of the heating proportional band from the set point.		0 to 999 (0000 to 999000)	0	*279, 280 R/W	At least one output is set to HEAT and HEAT is set to PID.
hhYS [h.hyS]	Heat Hysteresis Set the control switching hysteresis for on-off control. This determines how far into the "on" region the input needs to move before the output actually turns on.		1 to 999 degrees, if SEN is set to tc or rtD (1000 to 999000) 0.000 to 999.999 units, if SEN is set to PTA or uolt (0000 to 999999)	1.0 1.000	*232, 233 R/W *234, 235 R/W	At least one output is set to HEAT , and HEAT is set to onof .
CLM [CL.M]	Cool Control Method Set the Cool Control Method		OFF off (0) PID PID (1) onof on-off (2)	OFF (0)	214 R/W	At least one output is set to COOL .
PbCL [Pb.CL]	Proportional Band Cool Set the proportional band for the cool outputs.		1 to 999°F if SEN is set to tc or rtD (1000 to 999000) 0.000 to 999.0 if SEN is set to PTA or uolt (0000 to 999000)	25 25.000	*218, 219 R/W *222, 223 R/W	At least one output is set to COOL , and CLM is set to PID .
rECL [rE.CL]	Reset Cool Set the PID reset in repeats per minute for the cool output.		0.00 to 99.99 repeats per minute (0000 to 99990) 0.00: disabled	0.00	*226, 227 R/W (Modbus value is integral, which is the inverse of reset.)	At least one output is set to COOL , CLM is set to PID , and Unit is set to US .
ItCL [It.CL]	Integral Cool Set the PID integral in minutes per repeat for the cool outputs.		0.00 to 99.99 minutes per repeat (0000 to 99990) 0.00: disabled	0.00	*226, 227 R/W	At least one output is set to COOL , CLM is set to PID , and Unit is set to SI .

Note: Parameters appear on the Operations Page only if activated from the Programming Page. See page 21 for Operations Page defaults.

Note: Some values will be rounded off to fit in the four-character display. Full values can be read with Modbus.

* Low register numbers contain the two higher bytes; high register numbers contain the two lower bytes of the four-byte integer. Decimal precision is implied at three decimal places unless otherwise noted.

Caution: Writing to registers continuously, such as ramping set points via comms, will damage the SD31 EEPROM memory. See page 47.

Display	Parameter Name Description	Settings	Range (Integer values for Modbus in parentheses.)	Default	Modbus* (less 40,001 offset) Read/Write	Appears if:
<input type="checkbox"/> Rate Cool [rA.CL]	Rate Cool Set the PID rate time in minutes for the cool outputs.		0.00 to 9.99 minutes (0000 to 99990) 0.00: disabled	0.00	*230, 231 R/W	At least one output is set to <input type="checkbox"/> COOL , <input type="checkbox"/> CLP7 is set to <input type="checkbox"/> PI d , and <input type="checkbox"/> Unit is set to <input type="checkbox"/> US .
<input type="checkbox"/> Derivative Cool [dE.CL]	Derivative Cool Set the PID derivative time in minutes for the cool outputs.		0.00 to 9.99 minutes (0000 to 99990) 0.00: disabled	0.00	*230, 231 R/W	At least one output is set to <input type="checkbox"/> COOL , <input type="checkbox"/> CLP7 is set to <input type="checkbox"/> PI d , and <input type="checkbox"/> Unit is set to <input type="checkbox"/> SI .
<input type="checkbox"/> Dead Band Cool [db.CL]	Dead Band Cool An offset of the cooling proportional band from the set point.		0 to 999 (0000 to 999000)	0	*281, 282 R/W	At least one output is set to <input type="checkbox"/> COOL and <input type="checkbox"/> CLP7 is set to <input type="checkbox"/> PI d .
<input type="checkbox"/> Cool Hysteresis [C.hyS]	Cool Hysteresis Set the control switching hysteresis for on/off control. This determines how far into the “on” region the input needs to move before the output actually turns on.		1 to 999°F if <input type="checkbox"/> SEN is set to <input type="checkbox"/> tc or <input type="checkbox"/> rt d (1000 to 999000) 0.000 to 999.9 if <input type="checkbox"/> SEN is set to <input type="checkbox"/> 778 or <input type="checkbox"/> uolt (0000 to 999000)	1 1.000	*236, 237 R/W *238, 239 R/W	At least one output is set to <input type="checkbox"/> COOL and <input type="checkbox"/> CLP7 is set to <input type="checkbox"/> onoff .
<input type="checkbox"/> Proportional Term [ProP]	Proportional Term View the active proportional term for PID diagnostics.		*0.000 to 1.000 (0000 to 1000)	NA	258 R	Any output is set to <input type="checkbox"/> HEAT or <input type="checkbox"/> COOL .
<input type="checkbox"/> Integral Term [it]	Integral Term View the active integral term for PID diagnostics.		* 0.000 to 1.000 (0000 to 1000)	NA	259 R	Any output is set to <input type="checkbox"/> HEAT or <input type="checkbox"/> COOL .
<input type="checkbox"/> Derivative Term [dE]	Derivative Term View the active derivative term for PID diagnostics.		*0.000 to 1.000 (0000 to 1000)	NA	260 R	Any output is set to <input type="checkbox"/> HEAT or <input type="checkbox"/> COOL .

*This value multiplied by 100 equals the percent power.

Note: Parameters appear on the Operations Page only if activated from the Programming Page. See page 21 for Operations Page defaults.

Note: Some values will be rounded off to fit in the four-character display. Full values can be read with Modbus.

* Low register numbers contain the two higher bytes; high register numbers contain the two lower bytes of the four-byte integer. Decimal precision is implied at three decimal places unless otherwise noted.

Caution: Writing to registers continuously, such as ramping set points via comms, will damage the SD31 EEPROM memory. See page 47.

Display	Parameter Name Description	Settings	Range (Integer values for Modbus in parentheses.)	Default	Modbus* (less 40,001 offset) Read/Write	Appears if:
A1h [A1.hi]	Alarm 1 High Set the high alarm set point.		Deviation: 0 to 9999 (0000 to 9999000) Process: range of sensor; if SEN is set to EC or RTD -1999 to 9999 if SEN is set to P7A or VOLT . (-1999000 to 9999000)	999 (dev) 1500 (pro)	*100, 101 R/W (dev) *104, 105 R/W (pro)	DE 1 is set to DEAL or PRAL .
A1Lo [A1.Lo]	Alarm 1 Low Set the low alarm set point.		Deviation: -1999 to 0 (-1999000 to 0000) Process: range of sensor; if SEN is set to EC or RTD -1999 to 9999 if SEN is set to P7A or VOLT . (-1999000 to 9999000)	-999 (dev) 32 (pro)	*98, 99 R/W (dev) *102, 103 R/W (pro)	DE 1 is set to DEAL or PRAL .
A2h [A2.hi]	Alarm 2 High Set the high alarm set point.		Deviation: 0 to 9999 (0000 to 9999000) Process: range of sensor; if SEN is set to EC or RTD -1999 to 9999 if SEN is set to P7A or VOLT . (-1999000 to 9999000)	999 (dev) 1500 (pro)	*115, 116 R/W (dev) *119, 120 R/W (pro)	DE 2 is set to DEAL or PRAL .
A2Lo [A2.Lo]	Alarm 2 Low Set the low alarm set point.		Deviation: -1999 to 0 (-1999000 to 0000) Process: range of sensor; if SEN is set to EC or RTD -1999 to 9999 if SEN is set to P7A or VOLT . (-1999000 to 9999000)	-999 (dev) 32 (pro)	*113, 114 R/W (dev) *117, 118 R/W (pro)	DE 2 is set to DEAL or PRAL .

Note: Parameters appear on the Operations Page only if activated from the Programming Page. See page 21 for Operations Page defaults.



Note: Some values will be rounded off to fit in the four-character display. Full values can be read with Modbus.





* Low register numbers contain the two higher bytes; high register numbers contain the two lower bytes of the four-byte integer. Decimal precision is implied at three decimal places unless otherwise noted.

Caution: Writing to registers continuously, such as ramping set points via comms, will damage the SD31 EEPROM memory. See page 47.

7

Factory Page and Calibration

To go to the Factory Page, press both the Down  and Up  keys for six seconds from the Home Page. **SEE** will appear in the display after three seconds. Continue to hold both keys until **FRct** appears in the display.

- Press the Down  or Up  keys to move through the Factory Page parameters.
- To view or change a parameter value, press and hold the **SET** Key.
- Press the Down  or Up  keys to change the parameter value.
- Press the Infinity Key  at any time to return to the Home Page.

Display	Parameter Name Description	Settings	Range (Integer values for Modbus in parentheses.)	Default	Modbus* (less 40,001 offset) Read/Write	Appears if:
RP7b [AMb]	Ambient Temperature Displays the current calculated ambient temperature.		-50.0 to 300.0°F	NA	277 R 278 R	Always active.
RP7n [A.Mn]	Minimum Recorded Ambient Temperature Displays the minimum recorded ambient temperature.		-50.0 to 300.0°F	NA	NA	Always active.
RP7R [A.MA]	Maximum Recorded Ambient Temperature Displays the maximum recorded ambient temperature.		-50.0 to 300.0°F	NA	NA	Always active.
dSPL [dSPL]	Display Intensity Increase or decrease the brightness of the upper and lower display.		15 to 100% duty	100	NA	Always active.
ROE1 [A.Ot1]	Output 1 Process Value Monitors Process Output 1 value via Modbus.		00.00 to 22.00 units (0000 to 2200)		283 R	Process output installed for Output 1
rEST [rEST]	Restore Factory Calibration Replaces the user calibration parameters with the factory calibration parameters.	<input type="checkbox"/> no (0) <input type="checkbox"/> YES (1)		<input type="checkbox"/> no (0)	208 R/W	Always active.
USrr [Usr.r]	Restore User Settings Restores the customer's configured settings.	<input type="checkbox"/> no (0) <input type="checkbox"/> YES (1)		<input type="checkbox"/> no (0)	209 R/W	Always active.
USrS [USr.S]	Save User Settings Saves the current customer-configured settings.	<input type="checkbox"/> no (0) <input type="checkbox"/> YES (1)		<input type="checkbox"/> no (0)	210 R/W	Always active.
dFLt [dFLt]	Default Parameters Reset all parameters to their default values.	<input type="checkbox"/> no (0) <input type="checkbox"/> YES (1)		<input type="checkbox"/> no (0)	207 R/W	Always active.
Oty1 [O.ty1]	Output 1 Type Displays the hardware type for Output 1.	<input type="checkbox"/> nonE none (0) <input type="checkbox"/> dC DC/open collect. (1) <input type="checkbox"/> rLAY mech. relay (2) <input type="checkbox"/> SSr solid-state relay (3) <input type="checkbox"/> Prac process (4)		<input type="checkbox"/> nonE (0)	202 R	Always active.

Display	Parameter Name Description	Settings	Range (Integer values for Modbus in parentheses.)	Default	Modbus* (less 40,001 offset) Read/Write	Appears if:
OEY2 [O.ty2]	Output 2 Type Displays the hardware type for Output 2.		<input type="radio"/> none (0) <input type="radio"/> DC/open collect. (1) <input type="radio"/> mech. relay (2) <input type="radio"/> solid-state relay (3) <input type="radio"/> communications (5)	<input type="radio"/> (0)	203 R	Always active.
Sid [S.id]	Software ID Displays the software ID number.		0 to 9999	NA	10 R	Always active.
SVER [S.VEr]	Software Version Displays the firmware revision.		0.00 to 99.99	NA	11 R	Always active.
SbLd [S.bLd]	Software Build Number Displays the software build number.		0 to 9999 Build Number	NA	13 R	Always active.
PLVr [PWR]	Power Type Displays the type of input power.		<input type="radio"/> high voltage <input type="radio"/> low voltage	NA	*NA	Always active.
Sn- [Sn-]	Serial Number 1 Displays the first four characters of the serial number.		0 to 9999	NA	7, 8 R	Always active.
Sn_ [Sn_]	Serial Number 2 Displays the last four characters of the serial number.		0 to 9999	NA	7, 8 R	Always active.
tc.50 [tc.50]	Thermocouple, 50mV Calibrate the thermocouple input to 50mV (see “Calibrating the Series SD31”).		<input type="radio"/> no <input type="radio"/> YES	<input type="radio"/> no	*NA	Always active.
tc.00 [tc.00]	Thermocouple, 0mV Calibrate the thermocouple input to 0mV (see “Calibrating the Series SD31”).		<input type="radio"/> no <input type="radio"/> YES	<input type="radio"/> no	*NA	Always active.
tc.32 [tc.32]	Thermocouple, 32°F Calibrate the thermocouple input to 0°C (32°F) (see “Calibrating the Series SD31”).		<input type="radio"/> no <input type="radio"/> YES	<input type="radio"/> no	*NA	Always active.
r.15 [r.15]	RTD, 15 ohm Calibrate the RTD input to 15 ohm (see “Calibrating the Series SD31”).		<input type="radio"/> no <input type="radio"/> YES	<input type="radio"/> no	*NA	Always active.
r.380 [r.380]	RTD, 380 ohm Calibrate the RTD input to 380 ohms. (see “Calibrating the Series SD31”).		<input type="radio"/> no <input type="radio"/> YES	<input type="radio"/> no	*NA	Always active.
v.1 [v.1]	Input Calibrate, 1.0 Volt Calibrate the process voltage input to 1.0 Volt (see “Calibrating the Series SD31”).		<input type="radio"/> no <input type="radio"/> YES	<input type="radio"/> no	*NA	Always active.
v.9 [v.9]	Input Calibrate, 9.0 Volt Calibrate the process voltage input to 9.0 Volt (see “Calibrating the Series SD31”).		<input type="radio"/> no <input type="radio"/> YES	<input type="radio"/> no	*NA	Always active.

Display	Parameter Name Description	Settings	Range (Integer values for Modbus in parentheses.)	Default	Modbus* (less 40,001 offset) Read/Write	Appears if:
<input type="checkbox"/> R4 [A.4]	Input Calibrate, 4.0 mA Calibrate the process current input to 4.0 mA (see “Calibrating the Series SD31”).	<input type="checkbox"/> no <input checked="" type="checkbox"/> YES	<input type="checkbox"/> no <input checked="" type="checkbox"/> YES	<input type="checkbox"/> no	*NA	Always active.
<input type="checkbox"/> R16 [A.16]	Input Calibrate, 16.0 mA Calibrate the process current input to 16.0 mA.	<input type="checkbox"/> no <input checked="" type="checkbox"/> YES	<input type="checkbox"/> no <input checked="" type="checkbox"/> YES	<input type="checkbox"/> no	*NA	Always active.
<input type="checkbox"/> O1.1v [O1.1v]	Output 1 Calibrate, 1.0 Volt The voltage process output transmits 1.000V.	<input type="checkbox"/> no <input checked="" type="checkbox"/> YES	<input type="checkbox"/> no <input checked="" type="checkbox"/> YES	<input type="checkbox"/> no	*NA	Process output installed for Output 1.
<input type="checkbox"/> O1.9v [O1.9v]	Output 1 Calibrate, 9.0 Volt The voltage process output transmits 9.000V.	<input type="checkbox"/> no <input checked="" type="checkbox"/> YES	<input type="checkbox"/> no <input checked="" type="checkbox"/> YES	<input type="checkbox"/> no	*NA	Process output installed for Output 1.
<input type="checkbox"/> O1.4A [O1.4A]	Output 1 Calibrate, 4.0 mA The current process output transmits 4.000 mA.	<input type="checkbox"/> no <input checked="" type="checkbox"/> YES	<input type="checkbox"/> no <input checked="" type="checkbox"/> YES	<input type="checkbox"/> no	*NA	Process output installed for Output 1.
<input type="checkbox"/> O1.16 [O1.16]	Output 1 Calibrate, 16.0 mA The current process output transmits 16.000 mA.	<input type="checkbox"/> no <input checked="" type="checkbox"/> YES	<input type="checkbox"/> no <input checked="" type="checkbox"/> YES	<input type="checkbox"/> no	*NA	Process output installed for Output 1.

* The Series SD31 controller can be calibrated only with the front panel controls. These parameters are not accessible through serial communications.

Calibrating the Series SD31

Warm up the unit for 20 minutes. To reach the calibration parameters, enter the Factory Page by pressing and holding both the Down Key \blacktriangledown and Up Key \blacktriangle for six seconds. Once on the Factory Page **[FACT]**, use the Down Key \blacktriangledown to select a parameter. Press and hold the **[SET]** Key to view or change the parameter value. The last parameters on the Factory Page are the input and output calibration parameters.

You can restore the original factory calibration with Restore Factory Calibration **[RESET]** (Factory Page).

***Note: INFOSENSE™ should be turned off while verifying calibration of the controller with a calibration source.**

Thermocouple Input Procedure

Equipment

- Type J reference compensator with reference junction at 0°C (32°F), or type J thermocouple calibrator to 0°C (32°F).
- Precision millivolt source, 0 to 50 mV minimum range, 0.002 mV resolution.

Input Setup and Calibration

1. Connect the correct power supply to terminals 1 and 2 (see Chapter Two).
2. Connect the millivolt source to terminals 11 (-) and 10 (+) with copper wire.
3. Enter 50.00 mV from the millivolt source. Allow at least 10 seconds to stabilize. Press the Down Key \blacktriangledown until the Thermocouple Calibration 50 mV parameter **[Ec.50]** appears. Press and hold the **[SET]** Key and change **[no]** to **[YES]** by pressing the Down Key \blacktriangledown . Release the **[SET]** Key and press the Down Key \blacktriangledown to store 50.000 mV input and move to the next parameter.
4. Enter 0.000 mV from the millivolt source. Allow at least 10 seconds to stabilize. At the Thermocouple Calibration 0 mV parameter **[Ec.00]**, press and hold the **[SET]** Key and change **[no]** to **[YES]** by pressing the Down Key \blacktriangledown . Release the **[SET]** Key and press the Down Key \blacktriangledown to store 0.000 mV input and move to the next parameter.
5. Disconnect the millivolt source and connect the reference compensator or thermocouple calibrator to terminals 11 (-) and 10 (+). With type J thermocouple wire, if using a compensator, turn it on and short the input wires. When using a type J calibrator, set it to simulate 0°C (32°F). Allow 10 seconds for the controller to stabilize. Press the Down Key \blacktriangledown until the Thermocouple Calibration 32° parameter **[Ec.32]**, appears. Press and hold the **[SET]** Key and change **[no]** to **[YES]** by pressing the Down Key \blacktriangledown . Release the **[SET]** Key and press the Down Key \blacktriangledown to store the 32° input. and move to the next parameter or press the Infinity Key ∞ to exit the Factory Page.
6. Rewire for operation and verify calibration.

RTD Input Procedure

Equipment

- 1 k Ω decade box with 0.01 Ω resolution.

Input Setup and Calibration

1. Connect the correct power supply to terminals 1 and 2 (see Chapter 2).
2. Connect the decade box to terminals 10 (S1), 11 (S3) and 8 (S2), with 20 to 24-gauge wire.
3. Enter 15.00 Ω from the decade box. Allow at least 10 seconds to stabilize. Press the Down Key \blacktriangledown until the RTD Calibration 15 Ω parameter **[r.15]** appears. Press and hold the **[SET]** Key and change **[no]** to **[YES]** by pressing the Down Key \blacktriangledown . Release the **[SET]** Key and press the Down Key \blacktriangledown to store 15 Ω input and move to the next parameter.
4. Enter 380.00 Ω from the decade box. Allow at least 10 seconds to stabilize. At the RTD Calibration 380 Ω parameter **[r.380]**, press and hold the **[SET]** Key and change **[no]** to **[YES]** by pressing the Down Key \blacktriangledown . Release the **[SET]** Key and press the Down Key \blacktriangledown to store 380 Ω input and move to the next parameter or press the Infinity Key ∞ to exit the Factory Page.
5. Rewire for operation and verify calibration.

Voltage Process Input Procedure

Equipment

- Precision voltage source, 0 to 10V minimum range, with 0.001V resolution.

Input Setup and Calibration

1. Connect the correct power supply to terminals 1 and 2 (see Chapter Two).
- ### Input
2. Connect the voltage source to terminals 11 (-) and 9 (+) of the controller.
 3. Enter 1.00V from the voltage source to the controller. Allow at least 10 seconds to stabilize. Press the Down Key \blacktriangledown until the Input Calibrate 1V parameter, **[u.1]** appears. Press and hold the **[SET]** Key and change **[no]** to **[YES]** by pressing the Down Key \blacktriangledown . Release the **[SET]** Key and press the Down Key \blacktriangledown to store 1.00V input and move to the next parameter.
 4. Enter 9.00V from the voltage source to the controller. Allow at least 10 seconds to stabilize. At the Input Calibrate 9V parameter, **[u.9]**, press and hold the **[SET]** Key and change **[no]** to **[YES]** by pressing the Down Key \blacktriangledown . Release the **[SET]** Key and press the Down Key \blacktriangledown to store 9.00V input and move to the next parameter or press the Infinity Key ∞ to exit the Factory Page.
 5. Rewire for operation and verify calibration.

Current Process Input Procedure

Equipment

- Precision current source, 0 to 20 mA range, with 0.01 mA resolution.

Input Setup and Calibration

1. Connect the correct power supply to terminals 1 and 2 (see Chapter Two).
2. Connect the current source to terminals 11(-) and 8(+).
3. Enter 4.00 mA from the current source to the controller. Allow at least 10 seconds to stabilize. Press the Down Key \blacktriangledown until the Input Calibrate 4 mA parameter, $[R4]$ appears. Press and hold the **SET** Key and change $[no]$ to $[YES]$ by pressing the Down Key \blacktriangledown . Release the **SET** Key and press the Down Key \blacktriangledown to store the 4 mA input and move to the next parameter.
4. Enter 16.00 mA from the current source to the controller. Allow at least 10 seconds to stabilize. At the Input Calibrate 16 mA parameter, $[R16]$, press and hold the **SET** Key and change $[no]$ to $[YES]$ by pressing the Down Key \blacktriangledown . Release the **SET** Key and press the Down Key \blacktriangledown to store the 16 mA input and move to the next parameter or press the Infinity Key ∞ to exit the Factory Page.
5. Rewire for operation and verify calibration.

Process Output Procedures

Equipment

- Precision volt/ammeter with 3.5-digit resolution.

Output 1 Setup and Calibration

1. Connect the correct power supply to terminals 1 and 2 (see Chapter Two).
- ### Volts
2. Connect the volt/ammeter to terminals 7 (-) and 6 (+).
 3. Press the Down Key \blacktriangledown until the Output 1 Calibrate 1 V parameter, $[O1.1V]$ appears. Press and hold the **SET** Key and change $[no]$ to $[YES]$ by pressing the Down Key \blacktriangledown . Release the **SET** Key. The voltage output value appears in the display. Press the Up \blacktriangle or Down Key \blacktriangledown to adjust the display value to match the value from the volt/ammeter. The unit should stabilize within one second. Repeat until the volt/ammeter reads 1.00 V, ± 0.1 V. Press the Down Key \blacktriangledown to store the value and move to the next parameter.
 4. At Output 1 Calibrate 9 V parameter $[O1.9V]$, press and hold the **SET** Key and change $[no]$ to $[YES]$ by pressing the Down Key \blacktriangledown . Release the **SET** Key. The voltage output value appears in the display. Press the Up \blacktriangle or Down Key \blacktriangledown to adjust the display value to match the value from the volt/ammeter. The unit should stabilize within one second. Repeat until the volt/ammeter reads 9.00 V, ± 0.1 V. Press the Down Key \blacktriangledown to store the value and move to the next parameter or press the Infinity Key ∞ to exit the Factory Page.
 5. Rewire for operation and verify calibration.

Milliamperes

6. Connect the volt/ammeter to terminals 7 (-) and 5 (+).
7. Press the Down Key \blacktriangledown until the Output 1 Calibrate 4 mA parameter, $[O1.4A]$ appears. Press and hold the **SET** Key and change $[no]$ to $[YES]$ by pressing the Down Key \blacktriangledown . Release the **SET** Key. The current output value appears in the display. Press the Up \blacktriangle or Down Key \blacktriangledown to adjust the display value to match the value from the volt/ammeter. The unit should stabilize within one second. Repeat until the volt/ammeter reads 4.00 mA, ± 0.1 mA. Press the Down Key \blacktriangledown to store the value and move to the next parameter.
8. At Output 1 Calibrate 16 mA parameter $[O1.16]$, press and hold the **SET** Key and change $[no]$ to $[YES]$ by pressing the Down Key \blacktriangledown . Release the **SET** Key. The current output value appears in the display. Press the Up \blacktriangle or Down Key \blacktriangledown to adjust the display value to match the value from the volt/ammeter. The unit should stabilize within one second. Repeat until the volt/ammeter reads 16.00 mA, ± 0.1 mA. Press the Down Key \blacktriangledown to store the value and move to the next parameter or press the Infinity Key ∞ to exit the Factory Page.
9. Rewire for operation and verify calibration.

Restoring Factory Calibration

- Press the Up \blacktriangle and Down \blacktriangledown keys together for six seconds until $[FACT]$ appears in the display.
- Press the Down Key \blacktriangledown to step through the parameters until the $[RESET]$ appears.
- Press and hold the **SET** Key and change $[no]$ to $[YES]$ by pressing the Down Key \blacktriangledown . Release the **SET** Key and press the Infinity Key ∞ to exit the Factory Page.

Notes:

8

Features

Saving and Restoring User Settings37
Operations Page37
Autotuning37
Manual Tuning38
Inputs38
INFOSENSE™ Temperature Sensing38
Calibration Offset38
Filter Time Constant39
Sensor Selection39
Access Lockout39
Set Point Low Limit and High Limit39
High Scale and Low Scale39
High Range and Low Range40
Control Methods40
Output Configuration40
Auto-Manual Control40
On-Off Control41
Proportional Control41
PI Control41
PID Control42
Dead Band42
Power limiting and power scaling42
Nonlinear output curve43
Independent Heat and Cool PID43
Variable Time Base43
Ramping44
Alarms44
Process or Deviation Alarms44
Alarm Set Points44
Alarm Hysteresis45
Alarm Latching45
Alarm Silencing45
Communications46
Overview46
Setting Up a Modbus Network46
Troubleshooting48
Error Messages50

Saving and Restoring User Settings

Recording setup and operations parameter settings for future reference is very important. If you unintentionally change these, you will need to program the correct settings back into the controller to return the equipment to operational condition.

After you program the controller and verify proper operation, use **USr.S** to save the settings into a special section of memory. If the settings in the controller are altered and you want to return the controller to the saved values, use **USr.r** to recall the saved settings.

To save the Setup and Operations parameters:

1. Ensure all the settings that you want to store are already programmed into the Setup Page and Operations parameters.
2. Press the Up **▲** and Down **▼** keys together for six seconds until **FRct** appears in the display.
3. Press the Down Key **▼** to step through the parameters until the **USr.S** parameter appears.
4. Press and hold the **SET** Key and change **no** to **YES** by pressing the Down Key **▼**.
5. Release the **SET** Key and press the Infinity Key **∞** to exit the Factory Page.

Note: Only perform the above procedure when you are sure that all the correct settings are programmed into the controller. Saving the settings overwrites any previously saved collection of settings. Be sure to document all the controller settings.

To restore a collection of saved settings:

1. Press the Up **▲** and Down **▼** keys together for six seconds until **FRct** appears in the display.
2. Press the Down Key **▼** to step through the parameters until the **USr.r** parameter appears.
3. Press and hold the **SET** Key and change **no** to **YES** by pressing the Down Key **▼**.
4. Release the **SET** Key and press the Infinity Key **∞** to exit the Factory Page.

Operations Page

Watlow's patented user-defined menu system improves operational efficiency. The user-defined Operations Page provides you with a shortcut to monitor or change the parameter values that you use most often. You can go directly to the Operations Page from the Home Page by pressing and holding the Infinity Key **∞**.

You can create your own Operations Page with as many as 20 of the active parameters from the list in the Keys and Displays chapter. When a parameter normally located on the Setup Page is placed on the Operations Page, it is accessible through both. If you change a parameter on the Operations Page, it is automatically changed in its original page. If you change a parameter in its original page it is automatically changed on the Operations Page.

The default parameters will automatically appear on the Operations Page.

To change the list of parameters appearing on the Operations Page, hold down the Infinity key **∞**, then press the Advance Key **⊙**, and hold both down for about six seconds until **PrOg** appears in the display. This is the Programming Page.

Press the Down Key **▼** once to go to the first Programming Page selection. The parameter choices P1-P20 appear in the display. Press and hold the **SET** Key and use the Up **▲** or the Down **▼** Key to change the selected parameter for each Programming Page location. If you do not want a parameter to appear for that location, select **none**. To change the other 19 selections, release the **SET** Key and use the Up **▲** or the Down **▼** Key to select **P1** to **P20**.

Changes made to the Operations Page will persist until changed by the operator or defaulted by full defaults or user defaults. User-defined parameters are not over-written by default parameters if those features become enabled. Only parameters supported by a controller's particular hardware configuration and programming settings will appear.

Autotuning

The autotuning feature allows the controller to measure the system response to determine effective settings for PID control. When autotuning is initiated the controller reverts to on-off control. The temperature must cross the Autotune Set Point four times to complete the autotuning process. Once complete, the controller controls at the normal set point, using the new parameters.

To initiate an autotune, set Autotune **Aut** (Operations parameters) to **On**.

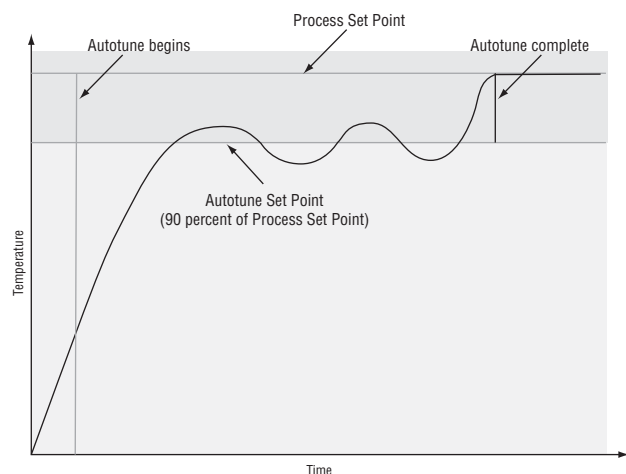

Manual Tuning

In some applications, the autotune process may not come up with PID parameters that provide the process characteristics you desire. If the autotune does not provide satisfactory results, you will have to perform a manual tune on the process:

1. Apply power to the Series SD31 and establish a set point typically used in your process.
2. Go to the Operations Page, and establish values for the PID parameters: Proportional Band = 5; Reset* = 0.00; Rate* = 0.00. Note: Autotune should be set to off.
3. When the system stabilizes, watch the process value. If this value fluctuates, increase the proportional band setting until it stabilizes. Adjust the proportional band in 3° to 5° increments, allowing time for the system to stabilize between adjustments.
4. When the Input has stabilized, watch the percent power , (Po.ht or Po.cl). It should be stable $\pm 2\%$. At this point, the process temperature should also be stable, but it will have stabilized before reaching set point. The difference between set point and actual can be eliminated with reset.
5. Start with a reset* value of 0.01 (99.99)** and allow 10 minutes for the process temperature to get to set point. If it has not, double (halve) ** the setting and wait another 10 minutes. Continue doubling (halving) ** every 10 minutes until the process value equals the set point. If the process becomes unstable, the reset* value is too large (small) **. Decrease (increase) ** the reset value until the process stabilizes.

6. Increase Rate* to 0.10 minute. Then increase the set point by 11° to 17°C. Monitor the system's approach to the set point. If the process value overshoots the set point, increase Rate* to 0.50 minute. Increase the set point by 11° to 17°C and watch the approach to the new set point. If you increase Rate* too much, the approach to the set point will be very sluggish. Repeat as necessary until the system rises to the new set point without overshoot or sluggishness.

*With the **INTE** parameter set at **51** (Setup Page) Integral will appear in place of Reset and Derivative will appear in place of Rate.

**Integral is the reciprocal of reset. For Integral instead of reset, use the values in parentheses.

For additional information about autotune and PID control, see related features in this chapter.

Inputs

INFOSENSE™ Temperature Sensing

Watlow's INFOSENSE™ feature can improve temperature sensing accuracy by 50%. Watlow's INFOSENSE™ thermocouples and RTD temperature sensors must be used together to achieve these results.

Each INFOSENSE™ “smart” sensor contains four

numeric values that are programmed into the SD memory. These values characterize Watlow sensors, for the controller to provide greater accuracy.

Turn the INFOSENSE™ feature on or off with INFOSENSE™ Enable **ISEn** (Setup Page). Set the four numerical values supplied with Watlow's INFOSENSE™ in the **ISP1**, **ISP2**, **ISP3** and **ISP4** parameters.

Contact your Watlow salesperson or Watlow authorized distributor for the pricing and availability of Watlow INFOSENSE™ products.

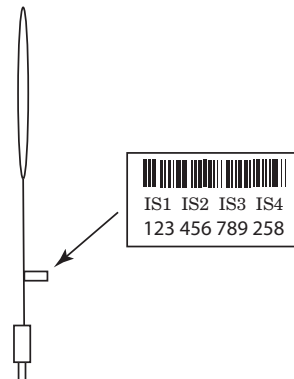

The four numerical values are found on the tag attached to the sensor.

Calibration Offset

Calibration offset allows a device to compensate for an inaccurate sensor, lead resistance or other factors that affect the input value. A positive offset increases the input value, and a negative offset decreases the input value.

The input offset value can be viewed or changed with Calibration Offset **CAL** (Operations parameters).

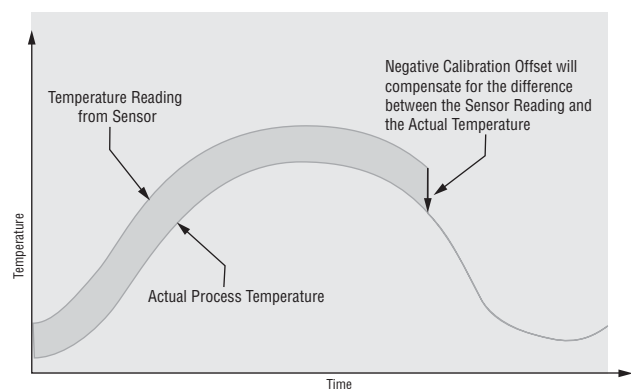

Filter Time Constant

Filtering smoothes an input signal by applying a first-order filter time constant to the signal. The displayed value, the controlled value or both the displayed and controlled values can be filtered. Filtering the displayed value makes it easier to monitor. Filtering the signal may improve the performance of PID control in a noisy or very dynamic system.

Select filter options with Input Filter **[FtrE]**. Select the Filter Value with **[FLtr]** (Setup Page).

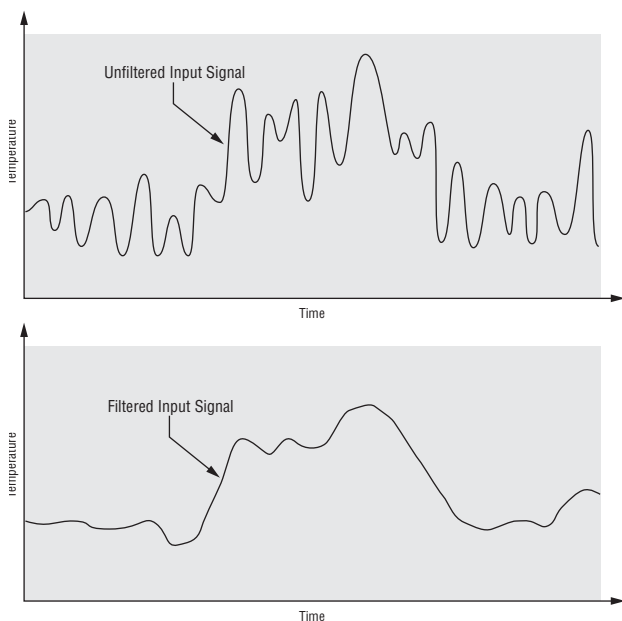

Sensor Selection

You need to configure the controller to match the input device, which is normally a thermocouple, RTD or process transmitter. When you select an input device, the controller automatically sets the input linearization to match the sensor. It also sets high and low limits, which in turn limit the set point range-high and range-low values.

Select the sensor type with Sensor Type **[SEn]** (Setup Page).

Access Lockout

The user's access to the Operations Page can be controlled through the **[Loc]** parameter. The **[Loc]** parameter appears at the end of the Setup Page. It does not affect the Setup, Factory or Programming Pages.

[0] All the Operations Page parameters may be viewed or changed.

[1] The set point, process value, auto-manual selection and alarm settings are the only visible Operations Page parameters. Set point is adjustable in this level. Auto-manual selection and autotune are permitted. During manual operation, the percent power is adjustable.

[2] The set point, process value, auto-manual selection and alarm settings are the only visible Operations Page parameters. Set point is adjustable in this level. Auto-manual selection is permitted. During manual operation, percent power is adjustable.

[3] The set point, process value and alarm settings are the only visible Operations Page parameters. Set point is adjustable. Auto-manual selection is **not** permitted. During manual operation, percent power is adjustable.

[4] The set point and process values are the only visible Operations Page parameters, set point is not adjustable. During manual operation, percent power is **not** adjustable.

Set Point Low Limit and High Limit

The controller constrains the set point to a value between a low limit and a high limit. The high limit cannot be set higher than the sensor high limit or lower than the low limit. The low limit cannot be set lower than the sensor low limit or higher than the high limit.

Set the set point range with Set Point Low **[SPLo]** and Set Point High **[SPHi]** (Setup Page).

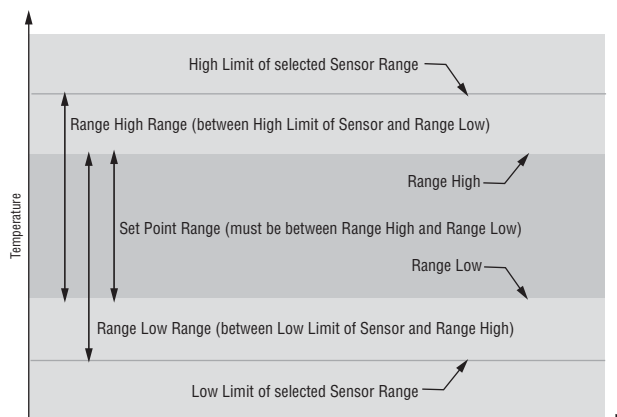

High Scale and Low Scale

When an analog input is selected as process voltage or process current input, you must choose the value of voltage or current to be the low and high ends. For example, when using a 4 to 20 mA input, the scale low value would be 4.00 mA and the scale high value would be 20.00 mA. Commonly used scale ranges are: 0 to 20 mA, 4 to 20 mA, 0 to 5V, 1 to 5V and 0 to 10V.

The Series SD31 allows you to create a scale range for special applications other than the standard ones listed above. Reversing of the scales from high values to low values is permitted for analog input signals that have a reversed action. For example, 50 psi = 4 mA and 10 psi = 20 mA.

Select the high and low values with Process Scale Low **[ScLo]** and Process Scale High **[ScHi]** (Setup Page).

High Range and Low Range

With a process input, you must choose a value to represent the low and high ends of the current or voltage range. Choosing these values allows the controller's display to be scaled into the actual working units of measurement. For example, the analog input from a humidity transmitter could represent 0 to 100 percent relative humidity as a process signal of 4 to 20 mA. Low scale would be set to 0 to represent 4 mA and high scale set to 100 to represent 20 mA. The indication on the display would then represent percent humidity and range from 0 to 100 percent with an input of 4 to 20 mA.

Select the high and low values with Units Scale Low **[r 9Lo]** and Units Scale High **[r 9hi]** (Setup Page).

Control Methods

Output Configuration

Each controller output can be configured as a heat output, a cool output, an alarm output or deactivated. No dependency limitations have been placed on the available combinations. The outputs can be configured in any combination. For instance, all three could be set to cool.

Analog outputs can be scaled for any desired current range between 0 and 20 mA or voltage range between 0 to 10V. The ranges can be reversed to high-to-low for reverse acting devices.

Heat and cool outputs use the set point and Operations parameters to determine the output value. All heat and cool outputs use the same set point value. Heat and cool each have their own set of control parameters. All heat outputs use the same set of heat control parameters and all cool outputs use the same set of cool output parameters.

Each alarm output has its own set of configuration parameters and set points, allowing independent operation.

Auto (closed loop) and Manual (open loop) Control

The controller has two basic modes of operation, auto mode and manual mode. Auto mode allows the controller to decide whether to perform closed loop control or to follow the settings of the Input Error Failure Mode parameter (Setup Page). The manual mode only allows open loop control. The Series SD controller is normally used in the auto mode. The manual mode is usually only used for specialty applications or for troubleshooting.

Manual mode is open loop control that allows the user to directly set the power level to the controller's output load. No adjustments of the output power level occur based on temperature or set point in this mode.

In auto mode, the controller monitors the input to determine if closed loop control is possible. The controller checks to make certain a functioning sensor is providing a valid input signal. If a valid input signal is present, the controller will perform closed loop control. Closed loop control uses a process sensor to determine the difference between the process value and the set point. Then the controller applies power to a control output load to reduce that difference.

If a valid input signal is not present, the controller will indicate an input error message **[Err In]** and then use the Input Error Failure Mode **[FRIL]** setting to determine operation. You can choose to have the controller perform a "bumpless" transfer, switch power to output a preset manual level, or turn the output power off.

Bumpless transfer will allow the controller to transfer to the manual mode using the last power value calculated in the auto mode if the process had stabilized at a ± 5 percent output power level for two minutes prior to sensor failure, and that power level is less than 75 percent.

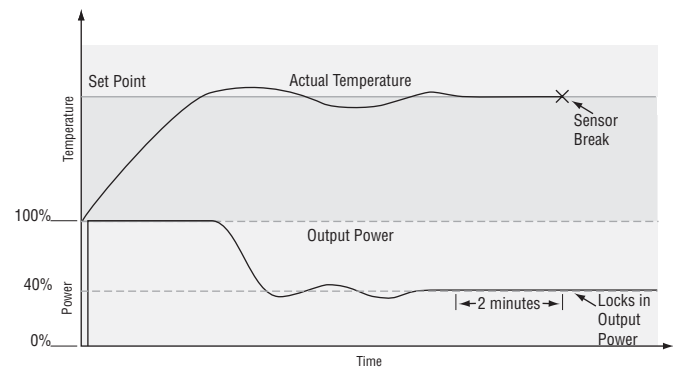

Input Error Latching **[IErr]** (Setup Page) determines the controller's response once a valid input signal returns to the controller. If latching is on **[LAE]**, then the controller will continue to indicate an input error until the error is cleared. To clear a latched alarm, press the Infinity Key **[∞]**. If latching is off **[nLAE]**, the controller will automatically clear the input error and return to reading the temperature. If the controller was in the auto mode when the input error occurred, it will resume closed loop control. If the controller was in manual mode when the error occurred, the controller will remain in open loop control.

The Auto-Manual Control Indicator Light % is on when the controller is in the manual mode and it is off while in the auto mode. You can switch between modes if the Auto-Manual Mode **[A-M]** parameter is selected to appear on the Operations Page.

To transfer to manual mode from auto mode, press the Infinity Key **[∞]** to get to the Operations Page. Press the Down Key **[↓]** until **[A-M]** appears in the display. Press and hold the **[SET]** Key to display **[Auto]** for auto mode. Use the Up **[↑]** or Down **[↓]** keys to select **[MAN]**. The manual set point value will be recalled from the last manual operation.

To transfer to auto mode from manual mode, press the Infinity Key ∞ to get to the Operations Page. Press the Down Key \blacktriangledown until $[R-P7]$ appears in the display. Press and hold the ESC Key to display $[P7Rn]$ for manual mode. Use the Up \blacktriangle or Down \blacktriangledown keys to select $[Auto]$. The automatic set point value will be recalled from the last automatic operation.

Changes take effect after three seconds or immediately upon moving to the next parameter or by pressing the Infinity Key ∞ .

On-Off Control

On-off control switches the output either full on or full off, depending on the input, set point and hysteresis values. The hysteresis value indicates the amount the process value must deviate from the set point to turn on the output. Increasing the value decreases the number of times the output will cycle. Decreasing hysteresis improves controllability. With hysteresis set to 0, the process value would stay closer to the set point, but the output would switch on and off more frequently, and may result in the output “chattering.” On-off control can be selected with Heat Control Method $[HEP7]$ or Cool Control Method $[CLP7]$ (Operations parameters).

NOTE:

Input Error Failure Mode $[FRIL]$ does not function in on-off control mode. The output goes off.

NOTE:

In on-off control set Power Limit 1 and 2 ($[PL1]$, and $[PL2]$) and Output Power Scale High 1 and 2 ($[PSH1]$ and $[PSH2]$) to 100%. Set Output Power Scale Low 1 and 2 ($[PSL1]$ and $[PSL2]$) to 0%.

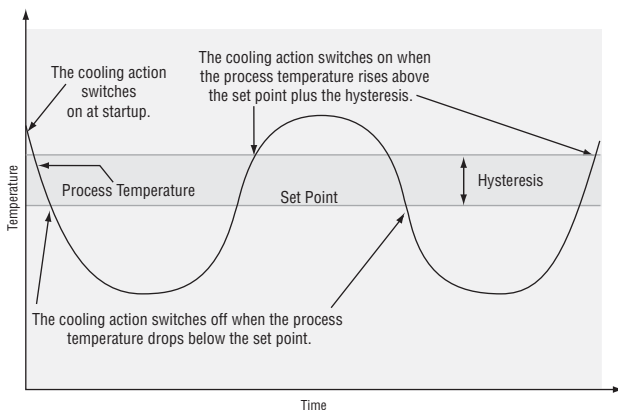
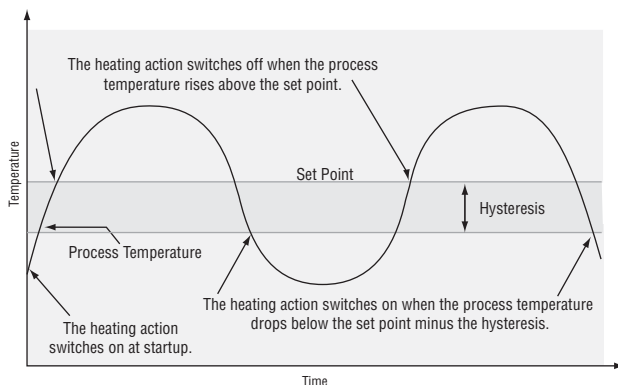

Proportional Control

Some processes need to maintain a temperature or process value closer to the set point than on-off control can provide. Proportional control provides closer control by adjusting the output when the temperature or process value is within a proportional band. When the value is in the band, the controller adjusts the output based on how close the process value is to the set point. The closer the process value is to the set point, the lower the output power. This is similar to backing off on the gas pedal of a car as you approach a stop sign. It keeps the temperature or process value from swinging as widely as it would with simple on-off control. However, when the system settles down, the temperature or process value tends to “droop” short of the set point.

With proportional control the output power level equals (set point minus process value) divided by the proportional band value.

Adjust the proportional band with Proportional Band Heat $[PbHE]$ or Proportional Band Cool $[PbCL]$ (Operations parameters).

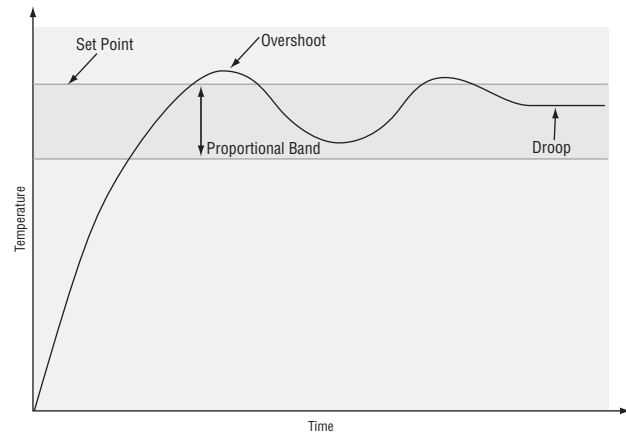

Proportional plus Integral (PI) Control

The droop caused by proportional control can be corrected by adding integral (reset) control. When the system settles down, the integral value is tuned to bring the temperature or process value closer to the set point. Integral determines the speed of the correction, but this may increase the overshoot at startup or when the set point is changed. Too much integral action will make the system unstable. Integral is cleared when the process value is outside of the proportional band.

Integral is in effect if PID Units are set to SI, and is measured in minutes per repeat. A low integral value causes a fast integrating action.

Reset is in effect if PID Units are set to U.S., and is measured in repeats per minute. A high reset value causes a fast integrating action.

Adjust the integral with Integral Heat $[IEHE]$ or Integral Cool $[IECL]$ (Operations parameters).

Adjust the reset with Reset Heat $[REHE]$ or Reset Cool $[RECL]$ (Operations parameters).

Proportional plus Integral plus Derivative (PID) Control

Use derivative (rate) control to minimize the overshoot in a PI-controlled system. Derivative (rate) adjusts the output based on the rate of change in the temperature or process value. Too much derivative (rate) will make the system sluggish.

Rate action is active only when the process value is within twice the proportional value from the set point.

Adjust the derivative with Derivative Heat **[dE.h.t]** or Derivative Cool **[dE.c.L]** (Operations parameters).

Adjust the rate with Rate Heat **[rA.h.t]** or Rate Cool **[rA.c.L]** (Operations parameters).

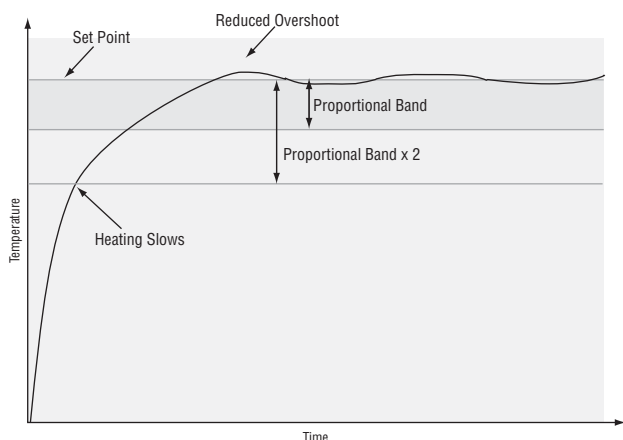

Dead Band

In a PID application the dead bands above and below the set point can save an application's energy and wear by maintaining process temperature within acceptable ranges. Shifting the effective cooling set point and heating set point keeps the two systems from fighting each other.

Proportional action ceases when the process value is within the dead band. Integral action continues to bring the process temperature to the set point. When the dead band value is zero, the heating element activates when the temperature drops below the set point, and the cooling element switches on when the temperature exceeds the set point.

Adjust the dead bands with Dead Band Heat **[db.h.t]** and Dead Band Cool **[db.c.L]** (Operations parameters).

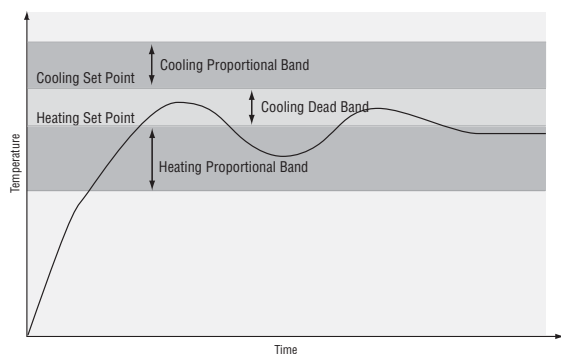

Power limiting and power scaling

Power limiting and power scaling are two methods of placing limitations on a control output. The functions can be used independently or together. An output level calculated from the PID algorithm first has the power limit applied, then the resulting value is processed using power scaling.

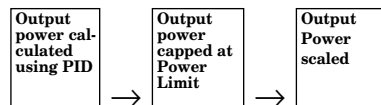

Using both power limiting and power scaling would not usually be necessary. Power limiting provides a basic static cap on power, while power scaling provides a more dynamic range of power limitation.

Note:

When output power must be limited, in most cases power scaling will provide better autotune performance than power limiting.

NOTE:

In on-off control set Power Limit 1 and 2 (**[PL 1]** and **[PL 2]**) and Output Power Scale High 1 and 2 (**[PSH 1]** and **[PSH 2]**) to 100%. Set Output Power Scale Low 1 and 2 (**[PSL 1]** and **[PSL 2]**) to 0%.

The power limit sets the maximum power for a heat or cool control output. Each control output has its own power limit. For heating outputs it determines the maximum level of heat power and for cool outputs it determines the maximum level of cooling power. A power limit of 100% in effect disables the power limit. If the PID calculations yield a power level that is greater than the power limit setting, then the output power level will be the power limit setting. For example, with a power limit setting of 70%, a PID-calculated power output of 50% would result in an actual output power level of 50%. But if the PID calculated power output is 100%, then the power level will be 70%.

Power scaling establishes the maximum power output and the minimum power output. The output power is then linearly scaled within that range. The default values of Output Power Scale Low of 0% and Output Power Scale High of 100% in effect disable power scaling.

Linear scaling allows the controller to do calculations over the full range of power (0 to 100%) and adjust that calculation within the actual output span. For instance, if scale low is set to 15% and scale high is set to 80%, the output power will always be between 15 and 80%. If the PID calculation is 100%, the output power will be 80%, which is the same result you would get from a power limit of 80%. However, if the PID calculation for heat is 50%, the output will be 50% of the allowable range, which scales to an actual output of 47.5%.

Power limiting and power scaling affect the specified output at all times, including in on-off control, manual mode and during autotuning.

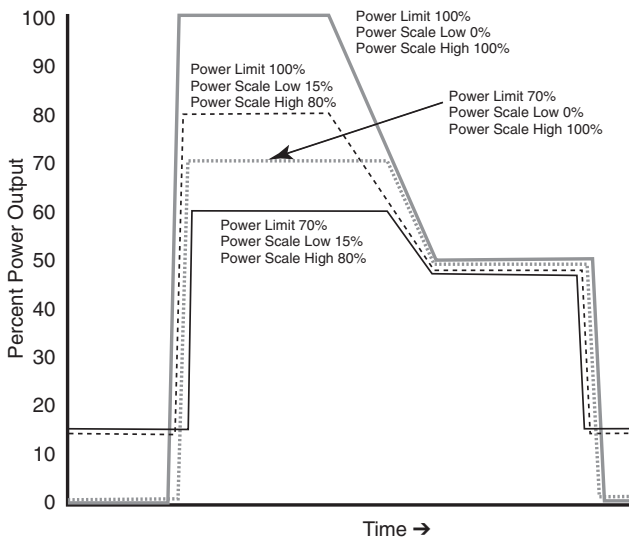

The Power Limit 1 and 2 (**PL 1** and **PL 2**) and Output Power Scale Low 1 and 2 (**PSL 1** and **PSL 2**) and Output Power Scale High 1 and 2 (**PSH 1** and **PSH 2**) appear on the Setup Page. The calculated PID heat and cool power values can be viewed with Power Heat **PhHt** and Power Cool **PoLL** parameters on the Operations Page.

Nonlinear output curve

A nonlinear output curve may improve performance when the response of the output device is nonlinear. If Output Nonlinear Function is set to curve 1 (**CrU1**) or curve 2 (**CrU2**), a PID calculation yields a lower actual output level than the linear output provides. These output curves are used in plastics extruder applications. Curve 1 is for air cooled extruders and curve 2 is for water cooled extruders.

Change the linearity for each output with Output Nonlinear Function 1 or 2 (**nLF 1** or **nLF 2**) on the Setup Page.

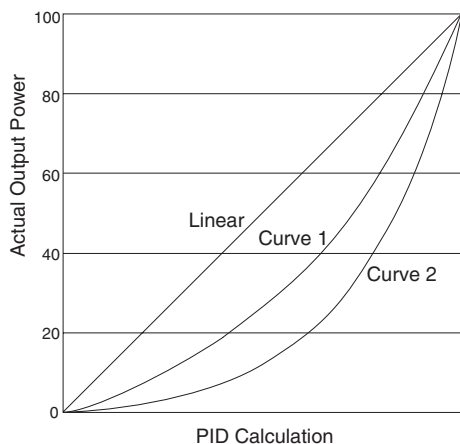

Independent Heat and Cool PID

In an application with one output assigned to heating and another assigned to cooling, each will have a separate set of PID parameters and separate dead bands. The heating parameters take effect when the process temperature is lower than the set point and the cooling parameters take effect when the process temperature is higher than the set point.

Adjust heat and cool PID parameters are Operations parameters.

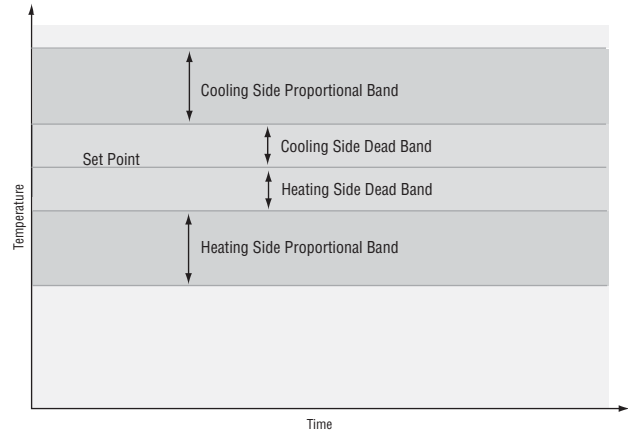

Variable Time Base

Variable time base is the preferred method for controlling a resistive load, providing a very short time base for longer heater life. Unlike phase-angle firing, variable-time-base switching does not limit the current and voltage applied to the heater.

With variable time base outputs, the PID algorithm calculates an output between 0 and 100%, but the output is distributed in groupings of three ac line cycles. For each group of three ac line cycles, the controller decides whether the power should be on or off. There is no fixed cycle time since the decision is made for each group of cycles. When used in conjunction with a zero cross (burst fire) device, such as a solid-state power controller, switching is done only at the zero cross of the ac line, which helps reduce electrical noise (RFI).

Variable time base should be used with solid-state power controllers, such as a solid-state relay (SSR) or silicon controlled rectifier (SCR) power controller. Do not use a variable time base output for controlling electromechanical relays, mercury displacement relays, inductive loads or heaters with unusual resistance characteristics.

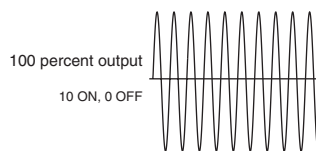

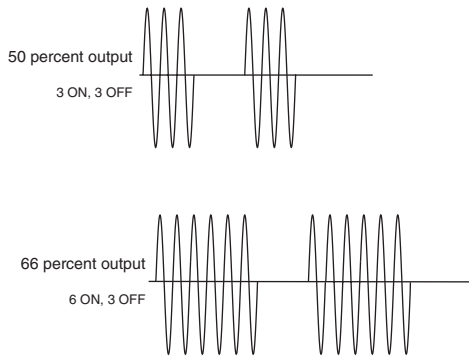

The combination of variable time base output and a solid-state relay can inexpensively approach the effect of analog, phase-angle fired control.

You must select the AC power line frequency, 50 or 60 Hz.

Ramping

Ramping protects materials and systems that cannot tolerate rapid temperature changes. The value of the ramp rate is the maximum degrees per minute or hour that the system temperature can change.

Select Ramping Mode **RP** (Setup Page):

OFF ramping not active.

Str ramp at startup.

On ramp at startup or when the set point changes.

Select whether the rate is in degrees per minute or degrees per hour with Ramp Scale **PSc** (Setup Page). Set the ramping rate with Ramp Rate **PRt** (Setup Page).

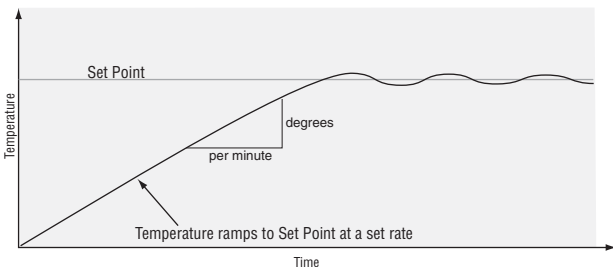
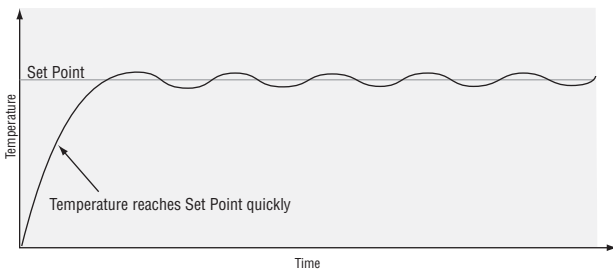

Alarms

Alarms are activated when the process value or temperature leaves a defined range. A user can configure how and when an alarm is triggered, what action it takes and whether it turns off automatically when the alarm condition is over.

Configure alarm outputs on the Setup Page before setting alarm set points.

Process or Deviation Alarms

A process alarm uses one or two absolute set points to define an alarm condition.

A deviation alarm uses one or two set points that are defined relative to the control set point. High and low alarm set points are calculated by adding and/or subtracting offset values from the control set point. If the set point changes, the window defined by the alarm set points automatically changes with it.

Select the alarm type with the Setup Page parameters. View or change process or deviation set points with the Operations parameters.

Alarm Set Points

The alarm high set point defines the process value or temperature that will trigger a high side alarm. It must be higher than the alarm low set point and lower than the high limit of the sensor range.

The alarm low set point defines the temperature that will trigger a low side alarm. It must be lower than the alarm high set point and higher than the low limit of the sensor range.

View or change alarm set points with the Operations parameters.

Alarm Hysteresis

An alarm state is triggered when the process value reaches the alarm high or alarm low set point. Alarm hysteresis defines how far the process must return into the normal operating range before the alarm can be cleared.

Alarm hysteresis is a zone inside each alarm set point. This zone is defined by adding the hysteresis value to the alarm low set point or subtracting the hysteresis value from the alarm high set point.

View or change alarm hysteresis Alarm 1 or 2 Hysteresis, **[HYS1]** or **[HYS2]** (Setup Page).

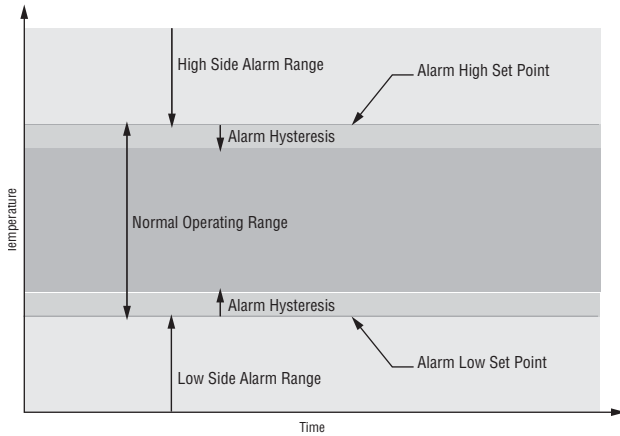

Alarm Latching

A latched alarm will remain active after the alarm condition has passed. To clear a latched alarm, press the Infinity Key ∞ . It can only be deactivated by the user. An alarm that is not latched (self-clearing) will deactivate automatically when the alarm condition has passed.

Turn alarm latching on or off with Alarm 1 or 2 Latching **[LAE1]** or **[LAE2]** (Setup Page).

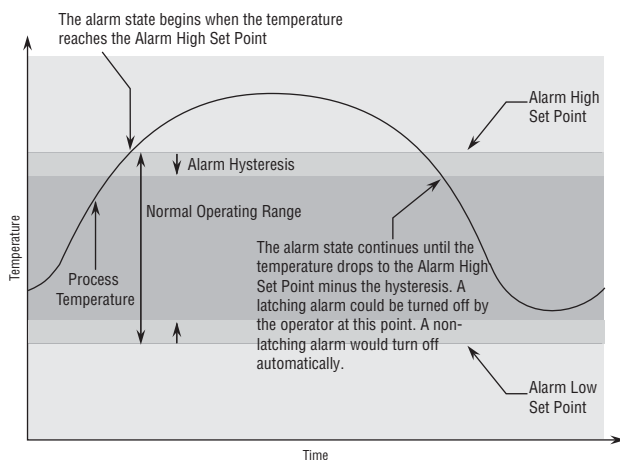

Alarm Silencing

Alarm silencing has two uses:

1. It is often used to allow a system to warm up after it has been started up. With alarm silencing on, an alarm is not triggered when the process temperature is initially lower than the alarm low set point. The process temperature has to enter the normal operating range beyond the hysteresis zone to activate the alarm function.
2. Alarm silencing also allows the operator to disable the alarm output while the controller is in an alarm state. The process temperature has to enter the normal operating range beyond the hysteresis zone to activate the alarm output function.

If the Series SD31 has an output that is functioning as a deviation alarm, the alarm is blocked when the set point is changed, until the process value re-enters the normal operating range.

Turn alarm silencing on or off with Alarm 1 or 2 Silencing **[SIL1]** or **[SIL2]** (Setup Page).

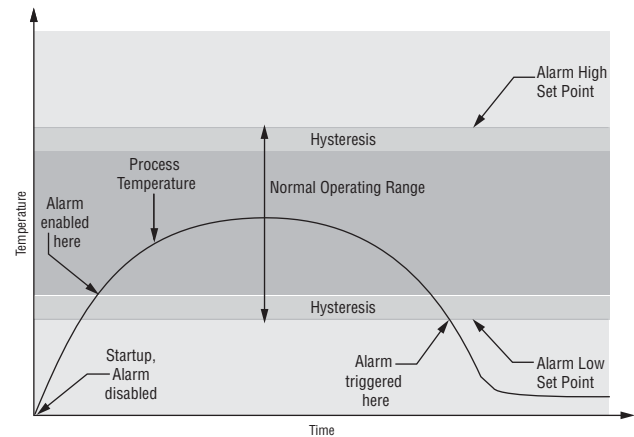

Communications

Overview

A Series SD31 controller can also be programmed and monitored by connecting it with a personal computer or programmable logic controller (PLC) via serial communications. To do this it must be equipped with an EIA/TIA 485 (SD__ - __ U_ - __ __) communications option for Output 2. Your PC or PLC must have available an EIA/TIA-485 interface or use an EIA/TIA-232 to EIA/TIA-485 converter. See “Selecting an EIA/TIA-232 to EIA/TIA-485 converter” in Chapter 2. The EIA/TIA-485 option directly supports communication with up to 32 devices on a network or up to 247 devices using a 485 repeater.

Basic communications settings must first be configured on the controller on the Setup Page. Match the Baud Rate (**Baud**) to that of the computer and select a unique Address (**Addr**) for each Series SD31.

To view or change controller settings with a personal computer, you need to run software that uses the Modbus RTU protocol to read or write to registers in the controller. See the parameter tables for information about the Modbus registers. These registers contain the parameter values that determine how the controller will function and current input and output values of the system. The address in the tables have been offset by subtracting 40,001 from each one.

Two consecutive registers are addressed for 32-bit data types. The first word, or lower register number, contains the two higher bytes. The second word, or higher register number, contains the two lower bytes of the four byte integer value.

Setting Up a Modbus Network

1. Wire the controllers.

The Series SD31 uses an EIA/TIA-485 serial port, which is not typically found in a PC, but can be found on many PLC's. The type of port found in a typical PC is an EIA-232 port. Internal EIA/TIA-485 PC ports are available, but the most common way for a PC to communicate using a EIA-485 port is with an EIA/TIA-232 to EIA/TIA-485 converter. See “Selecting an EIA/TIA-232 to EIA/TIA-485 converter” in Chapter 2.

The advantages of EIA/TIA-485 are that it is less susceptible to noise and it allows a PC or PLC to communicate with multiple controllers on the same port to form a network. It is important when using EIA/TIA-485, to install the termination resistors along with pull-up and pull-down resistors to ensure reliable communications.

Some newer PCs may only have a USB port. USB-to-serial adapters (usually EIA/TIA 232) are available from a variety of different PC vendors. Some companies offer adapters to convert from USB to EIA/TIA-485 directly.

2. Configure each controller's communications parameters on the Setup Menu using the front panel.

Only a couple of communications parameters need to be configured on the controller, Baud Rate and Modbus Address. The choices for Baud Rate are 9600 bps, 19200 bps or 38400 bps. 38400 baud allows for the fastest communication. For compatibility with other devices, reducing noise susceptibility, or increasing communications distance, 9600 bps could be chosen. When using EIA/TIA-485, all devices connected to that port must use the same Baud Rate. The Modbus address is used to identify each controller on the network. With EIA/TIA-485, every controller on the network must have a unique address.

3. Choose a device to communicate with the controller.

The controller can communicate with devices, such as a computer running a software program, a PLC (Programmable Logic Controller) or an OIT (Operator Interface Terminal). Whichever device is chosen, it needs to be able to communicate using the Modbus RTU Protocol. OITs would need to be ordered with Modbus RTU support. PLCs would either have Modbus RTU as a standard feature or it can be made available with an I/O module. On a computer, the software package to be used would need to have the Modbus RTU capability.

4. Select a software package for the computer.

Select the software package based on what is required from the application. For basic communications (such as reading the process value or setting the set point), Watlow has the Comm7 software package. This is mainly used for diagnostics and basic communications.

The WATVIEW™ software package offers more advanced features. WATVIEW™ is available in three editions, each offering increasing levels of functionality. If you need functionality beyond WATVIEW™ or need to interface with an existing software package, many other third party software packages can interface with the Series SD31.

When purchasing a third-party software package, be sure to look for a package that is Modbus RTU compatible or has Modbus RTU drivers. Most third-party packages require you to specify the Modbus registers of the controller to setup the package.

Another option is to custom-create a software package. Using the Modbus register and data information in this user's manual, a software package can be created and tailored to the desired application. To assist in application development, Watlow offers WATCONNECT™, which is a Windows-based software library for Modbus RTU communications. For further information on WATVIEW™ software packages, the WATCONNECT™ software library, or to download the Comm7 software, go to the Watlow web site at <http://www.watlow.com>.

5. Configure the software's communications parameters.

A software package, (be it software for a Computer, a PLC or an OIT) will need to be configured just as the controller was configured, setting the Baud Rate and Address to match. The software package may have additional parameters to set, such as number of data bits, parity and stop bits. For Watlow controllers using modbus, these should always be set at 8 data bits, no parity, and 1 stop bit. This is often written as "8N1". Some software packages may give the option to control the activity of the RTS, CTS and DTR lines, which are sometimes used by EIA-232 to EIA-485 converters. On packages where the Modbus registers for the controller need to be defined, these values can be entered at this time. Be sure to account for offsets.

6. Test the communications.

Once communications is configured, test the link to the controller for verification that everything is wired and configured properly. Check the wiring and configurations if things aren't working. One misplaced wire or one incorrect setting will keep communications from working. When using an EIA-232 to EIA-485 converter, be sure to follow the configuration instructions provided with the converter, as some may require special jumper/switch settings, external power supply requirements or special signals from the software. Some software packages have built-in routines for testing the communications or use Comm6 to help diagnose problems.

7. Start communications with the controller.

With the communications successfully verified, the software is now ready for use with the controller. The above guidelines are the general steps to establishing communications with controllers using Modbus. Some applications may require other steps not mentioned, but would follow the same general process.

8. Programming and configuring the controllers.

When programming and configuring the controllers with a software program, a couple of things must be kept in mind. If the software allows changing Setup parameters such as Input Type, other parameter values that are dependent on that setting may be automatically changed. Some software packages may warn you of this possibility and others may not.

Also, some controllers require that any changes made by the software program to controller parameters that need to be retained in the controller memory must be saved in the non-volatile memory writes register. Any settings not saved to controller memory will be lost when the controller's power is turned off.

Writing to Non-Volatile Memory

The Series SD31 stores parameter values in non-volatile EEPROM memory. This type of memory has a finite life of approximately 100,000 write cycles. In some applications, you might need to constantly write new values to a particular register. Examples might be the writing of ramping set points or repetitive loops through serial communications. Continuous writes may result in premature controller failure and system downtime.



To prevent premature failure of the EEPROM when frequently writing register values, write a 0 to register 17. Any values written after that, will not be stored to EEPROM. However, this data is lost when power is removed. Register 17 defaults to a value of 1 after each power cycle, writing values to EEPROM again. You must write a 0 to register 17 upon power up to prevent data from being written to EEPROM.

Troubleshooting

Indication	Probable Cause(s)	Corrective Action
<p>No power. Controller appears dead. No display indication in either window.</p>	<p>Power to unit may be off. Fuse may be blown. Breaker may be tripped. Safety interlock door switch, etc. may be activated. Separate system limit control may be latched. Wiring may be open. Input power may be incorrect.</p>	<p>Check switches, fuses, breakers, interlocks, limit devices, connectors, etc. for energized condition and proper connection. Measure power upstream for required level. Verify supply power requirements using the part number. Check wire size. Check for bad connections.</p>
<p>Set point value not displayed</p>	<p>Display Default [dSP] (Setup) is not set to [SET]. Press [SET] key to access set point.</p>	<p>Verify that [dSP] is at the desired setting.</p>
<p>Process value not displayed</p>	<p>Display Default [dSP] (Setup) is not set to [Proc]. Press [SET] key to access process value.</p>	<p>Verify that [dSP] is at the desired setting.</p>
<p>Cannot establish serial data communications with the controller.</p>	<p>Address parameter may be incorrectly set. Baud rate parameter may be incorrectly set. Unit-to-unit daisy chain may be disconnected. Communications wiring may be reversed, shorted or open. EIA-485 converter box may be incorrectly wired. Computer's COM port may be incorrectly set up. Communications software setup or address may be incorrect. PC software's protocol or parity may be wrong. Parity should be 8, n, 1. Application software is not working properly. May need termination, pull-up and pull-down resistors.</p>	<p>Check Setup Page and set to correct address. Check Setup Page and set to correct baud rate. Look for a break in the daisy chain. Verify correct connections and test wiring paths. Check converter box wiring and its documentation. Reconfigure computer's COM port setup and verify that communications are ok. Check the communication card documentation for settable variables and operational testing. Restart PC software and check for settings agreement. Verify the COM bus is active. Verify operation with Watlow communications tool available at www.watlow.com. Add termination resistors for EIA/TIA-485 (see Install and Wire chapter).</p>
<p>Output signal is on when it should not be.</p>	<p>Output wiring is incorrect.</p>	<p>Verify the output wiring.</p>
	<p>Output parameters are set incorrectly.</p>	<p>Verify the output parameter settings.</p>
	<p>DC voltage applied to output option "K" (solid-state relay output).</p>	<p>Solid-state relay option can be used with alternating current (ac) voltage only.</p>
<p>Output signal is not on when it should be.</p>	<p>Output wiring is incorrect.</p>	<p>Verify the output wiring.</p>
	<p>For solid-state relay (option "K") and mechanical relay (option "E" or "J"), power must be applied.</p>	<p>Verify that power is applied to the output. The output simply acts as a switch.</p>
	<p>Output parameters are set incorrectly.</p>	<p>Verify the output parameter settings.</p>

Indication	Probable Cause(s)	Corrective Action
Getting alarm message A h i , A 2 h i , A I L o , or A 2 L o .	The process value is beyond an alarm set point.	Determine when alarms messages will display and the proper response to an alarm message.
Alarm is occurring when it should not.	Alarm settings are incorrect.	Adjust the alarm settings to be correct for the application.
	Input may be in an error condition.	See error messages.
	Alarm may be latched.	Press the Infinity Key  to unlatch an alarm.
Alarm output indication is incorrect.	Alarm settings are incorrect.	Adjust the alarm settings to be correct for the application.
	Alarm may be silenced.	See the Features Chapter for information on alarm silencing.
Alarm is not occurring when it should.	Alarm settings are incorrect.	Adjust the alarm settings to be correct for the application.
Output cycles (turns on and off) too frequently.	Wrong control mode. PID control selected instead of On-Off control.	Select On-Off control mode (h e r r or l l r r Operations Page) and set the desired hysteresis value.
	The cycle time is not set properly.	Adjust the cycle time.
Controller does not control close enough to the set point.	Wrong control mode. On-Off control selected instead of PID. PID is not tuned properly.	Select PID control and perform tuning. Run autotune or perform manual tuning.
Controller's process value reading is decreasing but actual process is increasing.	Thermocouple polarity is reversed.	Check thermocouple connections. All thermocouple connections, including thermocouple extension wire, must maintain the correct polarity for proper operation.
	Analog voltage or analog current input scaling is reversed or incorrect.	Check the settings of the analog output scale low and scale high parameter (Setup Page).
Parameter(s) do not appear.	Parameter is not active.	See Setup and Operation chapters to determine when parameters should appear.
	Parameter lockout is active.	Set the correct level of lockout for access (Setup Page).
	Operations Page is not configured properly.	Select the desired parameters for the Programming Page.
Cannot access Operation Page. Cannot change the set point.	Parameter lockout is active.	Set the correct level of lockout for access (Setup Page).

Error Messages

Indication	Probable Cause(s)	Corrective Action
Er.In Input error	<p>The sensor may be improperly wired. Sensor wiring may be reversed, shorted or open.</p> <p>The input may be set to the wrong sensor or the controller may not be calibrated. Calibration may have been corrupted.</p>	<p>Check sensor connections.</p> <p>Check sensor connections and sensor wiring.</p> <p>Change Sensor Type SEn (Setup Page) to match the sensor hardware.</p> <p>Restore factory calibration.</p> <p>Press the Infinity Key  to reset latched input errors.</p>
Er.Ab Ambient temperature error	<p>Ambient temperature may be too hot or too cold.</p> <p>Calibration may be corrupted.</p>	<p>Verify that the temperature surrounding the controller is -18 to 65°C (0 to 149°F).</p> <p>Restore factory calibration.</p> <p>Cycle power.</p>
Er.CS Checksum error	<p>Settings may have changed unexpectedly.</p>	<p>Press the Infinity Key  to clear the error.</p> <p>Cycle power.</p> <p>Verify settings. If error message persists, contact the factory.</p>

A

Appendix

Specifications

(2369)

Controller

- 1/32 DIN, microprocessor-based, user-selectable control modes
- Heat and cool autotune for control outputs
- 1 Universal input, 2 outputs
- Control outputs user-selectable as on-off, P, PI, PID
- Display update: 10 Hz, adjustable digital filter
- Output update: burst, 0.1 to 999.9 seconds
- Communication output isolated
- Displayed in °C, °F or process units

Operator Interface

- Single 4-digit LED displays
- SET, Infinity (Home), Up Arrow, Down Arrow, tactile keys

Standard Conditions For Specifications

- Ambient temperature 25°C (77°F) ±3°C, rated line voltage, 50 to 60Hz, 0 to 90% RH non-condensing, 15-minute warm-up

Universal Input

- Sampling rate: 6.5 Hz.

Thermocouple

- Type J, K, T, E, N, C (W5), D (W3), PTII (F), R, S, B thermocouple types. Whole or tenth of a degree resolution.
- >20 MΩ input impedance
- Maximum 20 Ω source resistance

RTD

- 2- or 3-wire platinum, 100 Ω
- DIN curve (.00385 curve)
- Whole or tenth degree indication
- 390 μA nominal RTD excitation current

Process

- Range selectable: 0 to 10V_{rms} (dc), 0 to 5V_{rms} (dc), 1 to 5V_{rms} (dc), 0 to 20 mA, 4 to 20 mA. (Can reverse low and high values.)
- Voltage input impedance 20 kΩ
- Current input impedance 100 Ω
- Minimum current source resistance 1 MΩ
- Input resolution 50,000 bits (approximately) at full scale

Input Accuracy Span Ranges

Type J:	32	to	1,382°F	or	0	to	750°C
Type K:	-328	to	2,282°F	or	-200	to	1,250°C
Type T:	-328	to	662°F	or	-200	to	350°C
Type E:	-328	to	1,470°F	or	-200	to	799°C
Type N:	32	to	2,282°F	or	0	to	1,250°C
Type C (W5):	32	to	4,200°F	or	0	to	2,316°C
Type D (W3):	32	to	4,200°F	or	0	to	2,316°C
Type PTII (F):	32	to	2,540°F	or	0	to	1,393°C
Type R:	32	to	2,642°F	or	0	to	1,450°C
Type S:	32	to	2,642°F	or	0	to	1,450°C
Type B:	1,598	to	3,092°F	or	870	to	1,700°C
RTD:	-328	to	1,472°F	or	-200	to	800°C
Process:	-1,999	to	9,999 units				

Thermocouple Input

- Calibration accuracy: ±0.1% of input accuracy span ±1°C at standard conditions
- Temperature stability: ±0.2 degree per degree change in ambient for J, K, T, E, N, F
±0.3% for C and D
±0.4% for B, R (excluding 0 to 100°C) and S (excluding 0 to 100°C)
±0.5% for R and S (entire input accuracy range)

RTD Input

- Calibration accuracy ±0.1% of input accuracy span ±1°C at standard conditions
- Temperature stability: ±0.05 degree per degree change in ambient

Process Input

- Voltage input ranges
Accuracy ±10mV ±1 LSD at standard conditions
Temperature stability ±100 ppm/°C maximum
- Milliamp input ranges
Accuracy ±20μA ±1 LSD at standard conditions
Temperature stability ±100 ppm/°C maximum

Allowable Operating Ranges

Type J:	32	to	1,500°F	or	0	to	816°C
Type K:	-328	to	2,500°F	or	-200	to	1,371°C
Type T:	-328	to	750°F	or	-200	to	399°C
Type E:	-328	to	1,470°F	or	-200	to	799°C
Type N:	32	to	2,372°F	or	0	to	1,300°C
Type C (W5):	32	to	4,200°F	or	0	to	2,316°C
Type D (W3):	32	to	4,200°F	or	0	to	2,316°C
Type PTII (F):	32	to	2,543°F	or	0	to	1,395°C
Type R:	32	to	3,200°F	or	0	to	1,760°C
Type S:	32	to	3,200°F	or	0	to	1,760°C
Type B:	32	to	3,300°F	or	0	to	1,816°C
RTD (DIN)	-328	to	1,472°F	or	-200	to	800°C
Process	-1,999	to	9,999 units				

Output Types

- Output update rate: 6.5 Hz.

Switched DC

- Supply voltage minimum: 6V_{rms} (dc) @ 30 mA
- Supply voltage maximum: 12V_{rms} (dc) into an infinite load

Solid-state Relay

- Optically isolated
- Zero cross switched
- Without contact suppression
- Minimum load current: 10 mA rms
- Maximum current: 0.5A rms at 24 to 240V~ (ac), resistive
- 20 VA pilot duty, 120/240V~ (ac), inductive
- Must use RC suppression for inductive loads
- Maximum offstate leakage current: 100 μA rms

Electromechanical Relay, Form A

- Minimum load current: 10 mA
- 2 A @ 240V~ (ac) or 30V= (dc) maximum, resistive
- 125 VA pilot duty, 120/240V~ (ac), inductive
- Must use RC suppression for inductive loads
- Electrical life 100,000 cycles at rated current

Process *

- Range selectable: 0 to 20 mA, 4 to 20 mA, 0 to 5V= (dc), 1 to 5V= (dc), 0 to 10V= (dc)
- Reverse or direct acting
- 0 to 10V= (dc) voltage output into 1,000 Ω minimum load resistance
- 0 to 20 mA current output into 800 Ω maximum load resistance
- Resolution:
 - dc ranges: 2.5 mV nominal
 - mA ranges: 5 µA nominal
- Calibration accuracy:
 - dc ranges: ±15 mV
 - mA ranges: ±30 µA
- Temperature stability: 100 ppm/°C

Communications

EIA/TIA-485

- Isolated
- Modbus™ RTU protocol
- 9600, 19200 and 38400 baud rates
- A maximum of 32 units can be connected (with additional 485 repeater hardware, up to 247 units may be connected)
- Sampling rate: 20 Hz

Agency Approvals

- UL Listed Process Control UL3121® (UL 61010C-1), c-UL, CE, IP65 (NEMA 4X). File # E185611.
UL® is a registered trademark of the Underwriter’s Laboratories, Inc.
- CSA approved C22.2#24, File 158031
- NSF2 approved for type E, J, K, T, and RTD sensors. File 49660-0002-000

* Process output is not a retransmit output.

Terminals

- Touch-safe
- Input power and control outputs: 0.2 to 4 mm² (22 to 12 AWG), 6 mm (0.25 in) strip length
- Sensor inputs and process outputs: 0.1 to 0.5 mm² (28 to 20 AWG), 8 mm (0.30 in) strip length
- Solid or tinned wire recommended for spring clamp style connectors.
- Torque: terminal blocks 1 to 6 (SD _ _ _ _ [C, K or J] _ _ _ _ _ _) and 1 to 4 (SD _ _ _ _ F _ _ _ _ _ _) are 0.8 Nm (7 in-lb).

Power

- 100 to 240V~ (ac) +10%; -15%; 50/60 Hz, ±5%
- 24V≈ (ac/dc) +10%; -15%; 50/60 Hz, ±5%; Class 2 power source is required for low-voltage model.
- 10VA maximum power consumption
- Data retention upon power failure via nonvolatile memory

Operating Environment

- -18 to 65°C (0 to 149°F)
- 0 to 90% RH, non-condensing
- Storage temperature: -40 to 85°C (-40 to 185°F)

Dimensions

- Height - 29.7 mm (1.17 in)
- Width - 52.6 mm (2.07 in)
- Behind panel - 97.8 mm (3.85 in)

Functionality Matrix

	Universal Input	Control	Alarm	Process	485 Comm
Input 1					
Output 1					
Output 2					

Note: These specifications are subject to change without prior notice.

Ordering Information and Model Numbers (2370)

1/32 DIN Single display PID controller

S D 3 1 — A — A A

Power Supply H or L

- H 100 to 240V≈ (ac/dc)
- L 24V≈ (ac/dc)

Output 1 C, K, F or J

- C Switched DC
- K Solid-state Relay Form A, 0.5 Amp
- F Universal Process
- J Mechanical Relay Form A, 2 Amp

Output 2 A, C, K, J or U

- A None
- C Switched DC
- K Solid-state Relay Form A, 0.5 Amp
- J Mechanical Relay Form A, 2 Amp
- U EIA/TIA-485 Modbus Communications

Display Color and Custom Options

- 0R Red Display, Standard Overlay with Watlow Name
- 0G Green Display, Standard Overlay with Watlow Name
- AR Red Display, without Watlow Name
- AG Green Display, without Watlow Name
- XX Custom Options

For more information, go to www.watlow.com or contact your Watlow representative.

Index

- AC Line Frequency 23
- AC Power Wiring 6
- Access Lockout 24, 39
- Active Output Indicator Lights 14
- Address 46
- Adjust the set point 15
- Adjusting the set temperature 15
- Advance Key 14
- Agency Approvals 52
- Alarm 1 High 29
- Alarm 1 Hysteresis 22
- Alarm 1 Latching 22
- Alarm 1 Logic 22
- Alarm 1 Low 29
- Alarm 1 Message 22
- Alarm 1 Silencing 22
- Alarm 2 High 29
- Alarm 2 Hysteresis 22
- Alarm 2 Latching 23
- Alarm 2 Logic 23
- Alarm 2 Low 28
- Alarm 2 Message 23
- Alarm 2 Silencing 23
- Alarm High 1 Status 18
- Alarm High 2 Status 18
- Alarm Hysteresis 45
- Alarm Latching 45
- Alarm Low 1 Status 18
- Alarm Low 2 Status 18
- Alarm Message 14
- Alarm Set Points 44
- Alarm Silencing 45
- Alarm Features 44
- Ambient Temperature 30
- Ambient temperature error 50
- Analog Output 1 Scale High 21
- Analog Output 1 Scale Low 21
- Analog Output 1 Units 21
- Appendix 51
- Auto and Manual Control 40
- Auto (closed loop) control 40
- Auto-Manual Control Indicator Light 14
- Automatic Mode 14
- Automatic Send Data control 11
- Auto-Manual Mode 26
- Autotune 26
- Autotuning features 37
- B&B Converter 11
- Back View 4
- Baud Rate 24, 46
- Biasing and termination 11
- Calibration 33
- Calibration Offset 38
- Checksum error 50
- Closed Loop 40
- Closed Loop Set Point 18
- CMC Converter 11
- Communications features 46
- Communications specifications 52
- Connectors 4
- Control Method 1 21
- Control Method 2 21
- Control Methods features 40
- Cool Control Method 27
- Cool Hysteresis 28
- Current Process Input Calibration 34
- Current Ramp Set Point 18
- Cycle Time - see fixed time base
- Dead Band 42
- Dead Band Cool 28
- Dead Band Heat 27
- Default Parameters 30
- Derivative Cool 28
- Derivative Heat 27
- Derivative Term 28
- Deviation Alarms 44
- Dimensions 4
- Dimensions specifications 52
- Display Default 23
- Display Intensity 30
- EIA 232 to 485 Converter 11
- EIA/TIA-485 Communications 52
- EIA/TIA-485 wiring 10
- EM Gateway 12
- Error condition 14
- Error Messages 50
- Ethernet Gateway 12
- Factory Page 30
- Factory Page Overview 17
- Features and Benefits 2
- Filter Time Constant 39
- Filter Value 20
- Filtered Process Value 18
- Fixed Time Base 1 (Cycle Time) 21
- Fixed Time Base 2 (Cycle Time) 22
- Functionality Matrix 52
- Greenlee 4
- Heat Control Method 26
- Heat Hysteresis 27
- High Range and Low Range 40
- High Scale and Low Scale 39
- Home Page 18
- Home Page Overview 14
- Independent Heat and Cool PID 43
- Infinity Key 14
- Index 54
- INFOSENSE 19
- INFOSENSE 1-4 19
- INFOSENSE Temperature Sensing 3, 38
- Input Accuracy 51
- Input Accuracy Span Ranges 51
- Input Calibrate, 1.0 Volt 31
- Input Calibrate, 16.0 mA 32
- Input Calibrate, 4.0 mA 32
- Input Calibrate, 9.0 Volt 31
- Input Error 18, 50
- Input Error Failure Mode 23
- Input Error Latching 23
- Input Error Power 23
- Input Filter 20, 39
- Input Power Wiring 6
- Input ranges 51
- Inputs 38
- inputs and outputs 2
- Install and Wire 4
- Installation 5
- Integral Cool 27, 41
- Integral Heat 26, 41
- Integral Term 28
- IP65/NEMA 4X seal 5
- Isolation 11
- Isolation Blocks 6
- Keys and Displays 14
- Latching Input Error 23
- Latching Alarm 22, 23
- Lockout 24
- Low Voltage AC Power Wiring 6
- Manual (open loop) Control 40
- Manual Mode 14
- Maximum Recorded AmbientTemp. 30
- Measured Value 18
- Minimum Recorded AmbientTemp. 30
- Modbus Device Address 24
- Modbus Network 46
- Modbus RTU protocol 46
- Model Numbers 53
- National Electric Code (NEC) 4
- NEMA 4X 5
- Non-latching Alarm 45
- Non-latching Input Error 23
- Nonlinear output curve 43
- On-Off Control 41
- Open Loop 40
- Open Loop Output Power 18
- Operating Environment 52
- Operating Ranges 52
- Operations Page 37
- Operations Page Overview 15
- Operations Parameters Table 26
- Operator Interface 51
- Ordering Information 53
- Output 1, Switched DC wiring 9
- Output 1 Calibrate, 1.0 Volt 32
- Output 1 Calibrate, 16.0 mA 32
- Output 1 Calibrate, 4.0 mA 32
- Output 1 Calibrate, 9.0 Volt 32
- Output 1 Function 20
- Output 1 Mechanical Relay Wiring 8
- Output 1 Process Value 30
- Output 1, Process wiring 9
- Output 1, Solid-state Relay wiring 8
- Output 1 Type 30
- Output 2 EIA/TIA-485 wiring 10
- Output 2 Function 21
- Output 2, Mechanical Relay wiring 9
- Output 2, Solid-state Relay Wiring 10
- Output 2, Switched DC Wiring 10
- Output 2 Type 31
- Output Configuration 40
- Output Nonlinear Function 1 21
- Output Nonlinear Function 2 22
- Output Power Scale High 1 21
- Output Power Scale High 2 22
- Output Power Scale Low 1 21
- Output Power Scale Low 2 22
- Output Types 51
- Overview 2
- Paktron 8
- PI Control 41

PID Control 42
 Power Cool 26
 Power Limit 1 21
 Power Limit 2 22
 Power limiting 42
 Power scaling 42
 Power specifications 52
 Power Type 31
 Power Wiring 6
 Process Alarms 44
 Process Decimal Places 19
 Process Input, 0 to 20 mA wiring 8
 Process Input, 0 to 10V wiring 7
 Process Output Calibration 34
 Process Scale High 20, 39
 Process Scale Low 20, 39
 Process Value 18
 Programming Page Overview 17
 Prompt Index 56
 Proportional Band Cool 27, 41
 Proportional Band Heat 26, 41
 Proportional Control 41
 Proportional + Integral (PI) Control 41
 Proportional + Integral + Derivative (PID) Control 42
 Proportional Term 28
 Quencharc 8
 Ramp Rate 24, 44
 Ramp Scale 23, 44
 Ramp Target Set Point 18, 44
 Ramping 44
 Ramping Home Page display 14
 Ramping Mode 23, 44
 Rate Cool 28
 Rate Heat 27
 Removal 5
 Reset Cool 27, 41
 Reset Heat 26, 41
 Restore Factory Calibration 30
 Restore User Settings 30
 Restoring Factory Calibration 34
 Restoring User Settings 34
 RTD Input Wiring 7
 RTD Input Calibration 33
 RTD, 15 ohm 31
 RTD, 380 ohm 31
 Save User Settings 30
 Saving and Restoring User Settings 36
 Sensor Selection 39
 Sensor Type 19
 Serial Number 1 31
 Serial Number 2 31
 Set Point High 39
 Set Point High Limit 20
 Set Point Low 39
 Set Point Low Limit 20
 Setting Up a Modbus Network 46
 Setup Page 19
 Setup Page Overview 16
 Software Build Number 31
 Software ID 31
 Software Version 31
 Specifications 51
 Standard Conditions For Specifications 51
 Table of Contents 1
 Temperature Decimal Places 19
 Temperature set point 15
 Temperature Units 19
 Terminals 52
 Thermocouple Input Wiring 7
 Thermocouple Input Calibration 33
 Thermocouple Linearization 19
 Thermocouple, 0mV 31
 Thermocouple, 32°F 31
 Thermocouple, 50mV 31
 Troubleshooting 48
 Two-wire capability 11
 Units of Measurement 23
 Units Scale High 20
 Units Scale Low 20
 Universal Input 51
 Up and Down Keys 14
 Variable Time Base 43
 Voltage Process Input Calibration 33
 WATCONNECT™ 46
 Watlow web site 46
 WATVIEW™ 2, 46
 Wiring
 0 to 10V = Process Input 7
 0 to 20mA Process Input 8
 EIA/TIA 232-485 Converter 11
 EM Gateway 12
 High Voltage AC Power Wiring 6
 Low Voltage AC Power Wiring 6
 Output 1 Mechanical Relay 8
 Output 1 Process 9
 Output 1 Solid-state Relay 8
 Output 1 Switched DC 9
 Output 2 EIA-485 10
 Output 2 Mechanical Relay 9
 Output 2 Solid-state Relay 10
 Output 2 Switched DC 10
 RTD Input 7
 Thermocouple Input 7

Prompt Index

<code>R4</code>	32	<code>nLF2</code>	22, 43
<code>R16</code>	32	<code>OL16</code>	32
<code>R1h</code>	29	<code>OL1u</code>	32
<code>R1Lo</code>	29	<code>OL4R</code>	32
<code>R2h</code>	29	<code>OL9u</code>	32
<code>R2Lo</code>	29	<code>Oh</code>	21
<code>RCLF</code>	23, 44	<code>OLo</code>	21
<code>Raddr</code>	24	<code>OPER</code>	26
<code>R77A</code>	30	<code>QEY1</code>	30
<code>R77B</code>	30	<code>QEY2</code>	32
<code>R77n</code>	30	<code>QE 1</code>	20
<code>R-P7</code>	26	<code>QE 2</code>	21
<code>RDW</code>	21	<code>PdEC</code>	19
<code>RDE1</code>	30	<code>PbCL</code>	27, 41
<code>Rut</code>	26	<code>Pbht</code>	26, 41
<code>bAud</code>	24, 46	<code>PL 1</code>	21, 42
<code>CRl</code>	26, 38	<code>PL 2</code>	22, 42
<code>C-F</code>	19	<code>PaCL</code>	26
<code>ChYS</code>	28	<code>PohE</code>	26
<code>CLP7</code>	27, 41	<code>ProP</code>	28
<code>Ctr1</code>	21	<code>Pro9</code>	17
<code>Ctr2</code>	21	<code>PSH1</code>	21, 42
<code>dbCL</code>	28, 42	<code>PSH2</code>	22, 42
<code>dbht</code>	27, 42	<code>PSL1</code>	21, 42
<code>dE</code>	28	<code>PSL2</code>	22, 42
<code>dELL</code>	42	<code>PlUr</code>	31
<code>dEht</code>	42	<code>r.15</code>	31
<code>dFLE</code>	30	<code>r.380</code>	31
<code>dSP</code>	23	<code>rACL</code>	28, 42
<code>dSP1</code>	22	<code>rAht</code>	27, 42
<code>dSP2</code>	23	<code>rECL</code>	27, 41
<code>dSPL</code>	30	<code>rEht</code>	26, 41
<code>ErAb</code>	50	<code>rESE</code>	30, 34
<code>ErCS</code>	50	<code>r9h</code>	20
<code>ErIn</code>	18, 50	<code>r9Lo</code>	20
<code>FRIL</code>	23	<code>rP</code>	18, 23
<code>FRct</code>	30	<code>rPrE</code>	24, 44
<code>FLtr</code>	20, 39	<code>rPSc</code>	23, 44
<code>Ftbi</code>	21	<code>rPE9</code>	18, 44
<code>Ftbb2</code>	22	<code>SbLd</code>	31
<code>FtrE</code>	20	<code>SdEC</code>	19
<code>hhYS</code>	27	<code>Sch</code>	20, 39
<code>hEP7</code>	26, 41	<code>ScLo</code>	20, 39
<code>hYS1</code>	22	<code>SEn</code>	19, 39
<code>hYS2</code>	22	<code>Sid</code>	31
<code>IErr</code>	23	<code>SIL1</code>	22, 45
<code>ISEn</code>	19, 38	<code>SIL2</code>	23, 45
<code>ISP1</code>	19, 38	<code>Sn-</code>	31
<code>ISP2</code>	19, 38	<code>Sn</code>	31
<code>ISP3</code>	19, 38	<code>SPh</code>	20, 39
<code>ISP4</code>	19, 38	<code>SPLo</code>	20, 39
<code>it</code>	28	<code>SUER</code>	31
<code>IECL</code>	26, 41	<code>tc</code>	19
<code>IEht</code>	26, 41	<code>tc00</code>	31
<code>LAEt</code>	22, 45	<code>tc32</code>	31
<code>LAEt2</code>	23, 45	<code>tc50</code>	31
<code>L9c1</code>	22	<code>U1</code>	31
<code>L9c2</code>	23	<code>U9</code>	31
<code>LIn</code>	19	<code>Unit</code>	23
<code>LDC</code>	24, 39	<code>USrr</code>	30, 37
<code>P77An</code>	23, 40	<code>USrS</code>	30, 37
<code>nLF1</code>	21, 43		

Declaration of Conformity

Series SD

Watlow Winona, Inc.
1241 Bundy Blvd.
Winona, MN 55987 USA

Declares that the following product:

Designation: **Series SD**
Model Numbers: SD (3, 4, 6, 8 or 9) (Any letter or number) – (H or L) (C, F, J or K) (A, C, J, K or U) (A, C, E, F or K) – (A or R) (any three letters or numbers)
Classification: Temperature control, Installation Category II, Pollution degree 2
Rated Voltage / Frequency: 100 to 240V~ (ac), 50 or 60 Hz **or** 24 to 28 V≈ (ac 50 or 60 Hz or dc)
Rated Power Consumption: 10VA maximum

Meets the essential requirements of the following European Union Directives by using the relevant standards shown below to indicate compliance.

89/336/EEC Electromagnetic Compatibility Directive

EN 61326: 1997 With A1:1998: Electrical equipment for measurement, control and laboratory use – EMC requirements (Industrial Immunity, Class B Emissions). A2:2002:
EN 61000-4-2: 1996 With A1, 1998: Electrostatic Discharge Immunity
EN 61000-4-3: 1997: Radiated Field Immunity
EN 61000-4-4: 1995: Electrical Fast-Transient / Burst Immunity
EN 61000-4-5: 1995 With A1, 1996: Surge Immunity
EN 61000-4-6: 1996: Conducted Immunity
EN 61000-4-11: 1994: Voltage Dips, Short Interruptions and Voltage Variations Immunity
EN 61000-3-2: ED.2. 2000: Harmonic Current Emissions
EN 61000-3-3: 1995 With A1:1998: Voltage Fluctuations and Flicker

73/23/EEC Low-Voltage Directive

EN 61010-1: 1993 With A1: 1995 Safety Requirements of electrical equipment for measurement, control and laboratory use. Part 1: General requirements

Raymond D. Feller III

Name of Authorized Representative

Winona, Minnesota, USA

Place of Issue

General Manager

Title of Authorized Representative

April 2003

Date of Issue



Signature of Authorized Representative

How to Reach Us

**TOTAL
CUSTOMER
SATISFACTION**
3 Year Warranty

Your Authorized Watlow Distributor:

Corporate Headquarters in the U.S.:

Watlow Electric Manufacturing Co.
12001 Lackland Road
St. Louis, Missouri, USA 63146
Telephone: +1 (314) 878-4600
Fax: +1 (314) 878-6814

Europe:

Watlow GmbH
Industriegebiet Heidig
Lauchwasenstr. 1, Postfach 1165
Kronau 76709 Germany
Telephone: +49 (0) 7253-9400 0
Fax: +49 (0) 7253-9400-44

Watlow France S.A.R.L.
Immeuble Somag, 16 Rue Ampère,
Cergy Pontoise CEDEX 95307 France
Telephone: +33 (1) 3073-2425
Fax: +33 (1) 3073-2875

Watlow Italy S.R.L.
Via Meucci 14,
20094 Corsico MI
Italy
Telephone: +39 (02) 4588841
Fax: +39 (02) 458-69954

Watlow Limited
Robey Close, Linby Industrial Estate,
Linby Nottingham England, NG15 8AA
Telephone: +44 (0) 115 9640777
Fax: +44 (0) 115 9640071

Latin America:

Watlow de México
Av. Fundación #5,
Col. Parques Industriales,
Querétaro, Qro. México CP-76130
Telephone: +52 (442) 217-6235
Fax: +52 (442) 217-6403

Asia/Pacific:

Watlow Australia Pty., Ltd.
23 Gladstone Park Drive,
Tullamarine, Victoria 3043 Australia
Telephone: +61 (39) 335-6449
Fax: +61 (39) 330-3566

Watlow China, Inc.
179, Zhong Shan Xi Road
Hong Qiao Cointek Bldg, Fl. 4, Unit P
Shanghai 200051 China
Telephone: +86 (21) 6229-8917
Fax: +86 (21) 6228-4654

Watlow Japan Ltd. K.K.
Azabu Embassy Heights 106,
1-11-12 Akasaka,
Minato-ku, Tokyo 107-0052 Japan
Telephone: +81 (03) 5403-4688
Fax: +81 (03) 5403-4646

Watlow Korea Co., Ltd.
3rd F. Taehong Bldg.
20-6, Seocho-gu Yangjae-dong
Seoul, Korea 137-130
Telephone: +82 (2) 575-9804
Fax: +82 (2) 575-9831

Watlow Malaysia Sdn Bhd
38B Jalan Tun Dr Awang
11900 Bayan Lepas
Penang Malaysia
Telephone: +60 (4) 641-5977
Fax: +60 (4) 641-5979

Watlow Singapore Pte. Ltd.
Ayer Rajah Crescent
#03-23, Ayer Rajah Industrial Estate
Singapore 139949
Telephone: +65 773 9488
Fax: +65 778 0323

Watlow Electric Taiwan
10F-1 No. 189
Chi-Shen 2nd Road,
Kaohsiung, Taiwan
Telephone: +886 (7) 288-5168
Fax: +886 (7) 288-5568