

**INSTRUCTIONS FOR THE 32A SERIES 1/32 DIN
MICROPROCESSOR BASED
TEMPERATURE /PROCESS CONTROL**



PROHEAT

Excellence in distribution

<http://www.proheatinc.com>

117 East Adams Street

P.O. Box 48

LaGrange, KY 40031

Phone (502) 222-1402 Fax (502) 222-0714

CONTENTS

INSTALLATION	4
WIRING	5
Wiring for Optional Inputs and Outputs	6
Wiring for 4 to 20mA Transmitter inputs	7
FRONT PANEL KEY FUNCTIONS	8
NOTATION CONVENTIONS FOR THE MENUS	10
THE HOME DISPLAY	10
PROGRAMMING AND OPERATION FOR RAMP / SOAK FEATURE	11
Theory of Operation	11
Program Setup	11
Ramp / Soak Operation	13
AUTO / MANUAL OPERATION	13
OPERATION OF SELF TUNE® FUNCTION	14
Theory of Operation	14
Program Setup and Operation	15
OPERATION AND PROGRAMMING OF OPTIONS	15
Options 924, 926, 928, Analog Remote Set Point	15
Option 934, 936, Isolated Analog Retransmission.	16
Option 948, 2-Stage Set Point.	16
Option 992, Serial Communication.	17
CHANGING PROGRAMMING FOR SET POINT 2 AND ALARM	18
FACTORY DEFAULT PROCEDURE	18
ALARM TYPE AND ACTION	19
MENU SELECTIONS	20
PRIMARY MENU	20
SECONDARY MENU	21
SECURE MENU	28
SPECIFICATIONS	35
DIAGNOSTIC ERROR MESSAGES.....	37
DIAGNOSTIC ERROR MESSAGES.....	38
DIMENSIONS	40

GETTING STARTED

1. Install the control as described on page 4.
2. Wire your control following the instructions on page 5. If you are using a two-wire transmitter as an input, see the drawing and instructions on page 7. Option wiring instructions are on page 6. Option descriptions are on page 4, and specific instructions start on page 16.
3. Most controls do not need many (if any) program changes to work on your process. For best results when programming changes are necessary, make all the necessary changes in the Secure Menu (page 28) before making changes to the Secondary Menu (page 21). If error messages occur, check the Diagnostic Error Messages on page 37 and 38 for help.

Take the example of a Model 32A010 that comes from the factory programmed for type J thermocouples. Suppose for this example you wish to change the input to type K and limit the set point range between 0° and 1000° C.

First, enter the Secure menu as instructed on page 5. Press the INDEX key until the display shows **Inp** and press the DOWN ARROW until the display shows **CA**. Don't forget to press the ENTER key to retain your setting.

Next, press the INDEX key to display **Unit**. Press the DOWN ARROW until the display shows **C**. Press ENTER.

Next, press the INDEX key until **SPL** is displayed (pass the **dPt** and **InPt** selections). Press the UP ARROW until the display shows **0**. Press ENTER.

Finally, press INDEX key to display **SPH**. Press the DOWN ARROW until the display shows **1000**. Press ENTER.

The necessary program changes are now complete. After 60 seconds the display will switch back to the temperature reading. If you want to return faster, press the UP ARROW and ENTER keys (at the same time) and then press the DOWN ARROW and INDEX keys (again at the same time). This will 'back out' of the menu and immediately display the temperature reading.

If you want to use Self Tune®, Auto/Manual, or the Ramp/Soak Programmer features, see the special sections on these items. Page numbers for these are in the Contents section on the previous page.

MODEL IDENTIFICATION

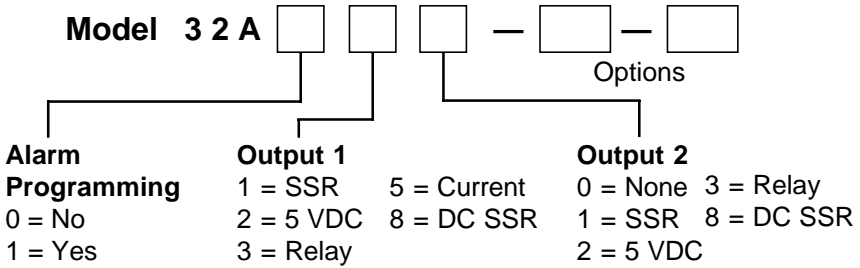

Options:

- 924 Analog Remote Set Point, 0 to 10 VDC.
- 926 Analog Remote Set Point, 4 to 20 mA DC.
- 928 Analog Remote Set Point, 0 to 10,000 ohms.
- 934 Analog Retransmission of Process Variable or Set Variable, 4 to 20 mA DC.
- 936 Analog Retransmission of Process Variable or Set Variable, 0 to 10 Vdc.
- 948 2-Stage Set Point. One of two pre-set set point values can be implemented via contact closure.
- 992 RS-485 Serial Communications. Allows remote computer to read and write all control parameters.
- 9502 12 - 24 Vdc/Vac 50-400Hz power supply (control operates on low voltage equipment).

Note: Only Option 9502 may be combined with another option. No other options may be combined.

INSTALLATION

Mount the instrument in a location that will not be subject to excessive temperature, shock, or vibration. All models are designed for mounting in an enclosed panel.

Select the position desired for the instrument on the panel. If more than one instrument is required, maintain the minimum of spacing requirements as shown on the drawing opposite. Closer spacing will structurally weaken the panel, and invalidate the IP66, UL type 4 rating of the panel.



It is not necessary to remove the control chassis from the housing for installation. If the control chassis is removed from the housing, you must follow industry standard practice for control and protection against Electro-Static Discharge (ESD). Failure to exercise good ESD practices may cause damage to the control.

Prepare the panel by cutting and deburring the required opening(s).

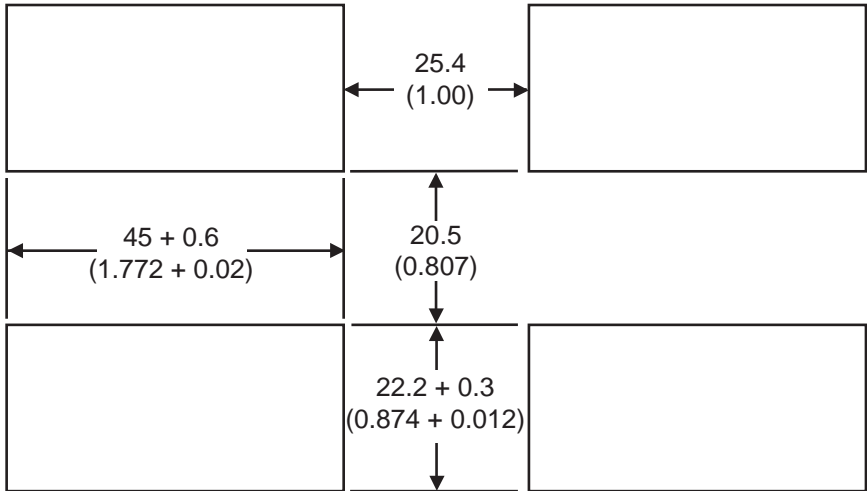

From the front of the panel, slide the housing through the cutout. The housing gasket should be flat against the housing flange before installing.

From the rear of the panel slide the mounting collar over the housing. Hold the housing with one hand and using the other hand, push the collar evenly against the panel until the spring loops are slightly compressed. The ratchets will hold the mounting collar and housing in place. To remove, gently lift the ratchets and slide a piece of heavy paper or mylar sheet under each ratchet (a business card works well). Slide the collar off of the housing.

WIRING

Do not run thermocouple or other class 2 wiring in the same conduit as power leads. Use only the type of thermocouple or RTD probe for which the control has been programmed. Maintain separation between wiring of sensor, auxiliary in or out, and other wiring. See the "Secure Menu" for input selection.

For thermocouple input always use extension leads of the same type designated for your thermocouple.

For supply connections use No. 18 AWG wires rated for at least 75°C. Use copper conductors only. All line voltage output circuits must have a common disconnect and be connected to the same pole of the disconnect.

Input wiring for thermocouple, current, and RTD; and output wiring for current, DC SSR, and 5 VDC is rated CLASS 2.

Control wiring is as shown.

The wiring terminals for the 32A are compression type. To open the wiring terminal, turn the screw for that terminal counterclockwise. Slide the wire into the terminal space. While holding the wire in place, turn

the screw clockwise to tighten. Maximum torque is 0.424 N·m(3.75 in. lb.). Do not overtighten. The wire should be held snugly in place.

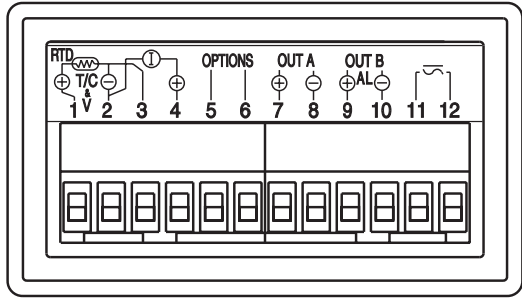

Wiring for Optional Inputs and Outputs

Wire power and outputs as shown on page 5 and 6. Wiring for options is shown below. All wiring shown below is Class 2. Shielded twisted pair is required for Option 992. Options 924, 926, and 928 share a common ground with input.



DO NOT RUN SIGNAL WIRING IN THE SAME CONDUIT OR CHASE AS THE POWER WIRING. ERRATIC OPERATION OR DAMAGE TO THE CONTROL CIRCUITRY WILL RESULT.

OPTION	Term. 5	Term. 6
924	- (minus)	+ (plus)
926	- (minus)	+ (plus)
928	Note 1	
934	- (minus)	+ (plus)
936	- (minus)	+ (plus)
948	Note 2	
992	Note 3	

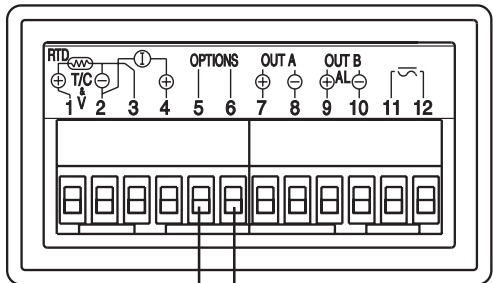

Note 1: Input is 0 to 10,000 ohms.

No polarity.

Note 2: Input is contact closure.

Open = 1SP1 Closed = 2SP1

Note 3: Terminal 5 is line A (-).

Terminal 6 is line B (+).

Last control in chain must have 120 ohm \pm 1% resistor across 5 and 6.

SWITCH CONTACTS FOR OPTION 948 MUST BE ISOLATED AND CAN NOT SHARE WIRING WITH OTHER CONTROLS.

Wiring for 4 to 20mA Transmitter inputs

Wire power and outputs as shown above. Two-wire transmitters wire as shown below.

For three or four wire transmitters follow the wiring instructions provided with your transmitter.



DO NOT WIRE THE 24 VOLT POWER SUPPLY ACROSS THE INPUT OF THE CONTROL. DAMAGE TO THE CONTROL INPUT CIRCUITRY WILL RESULT.

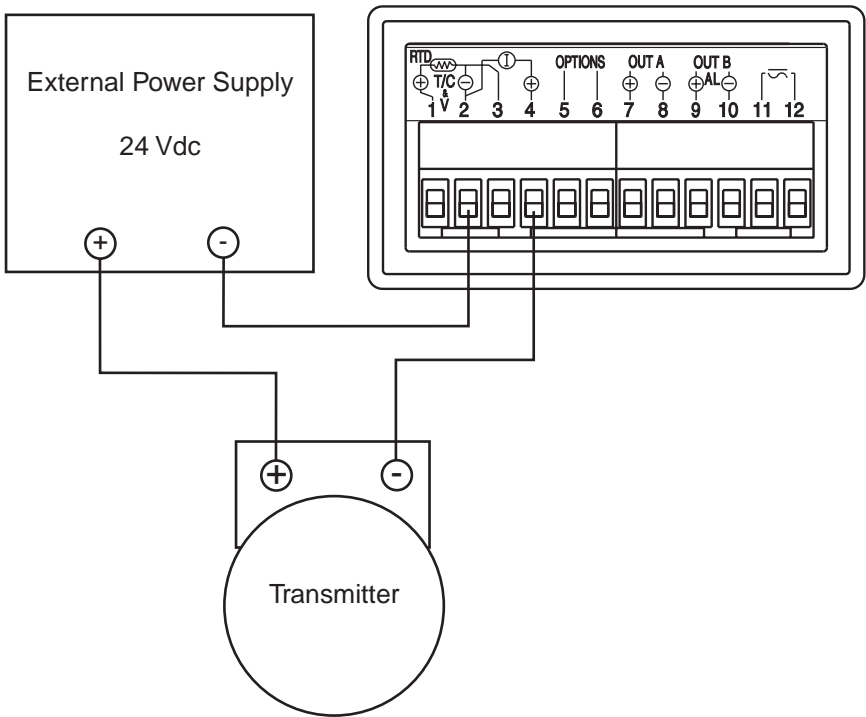

FRONT PANEL KEY FUNCTIONS

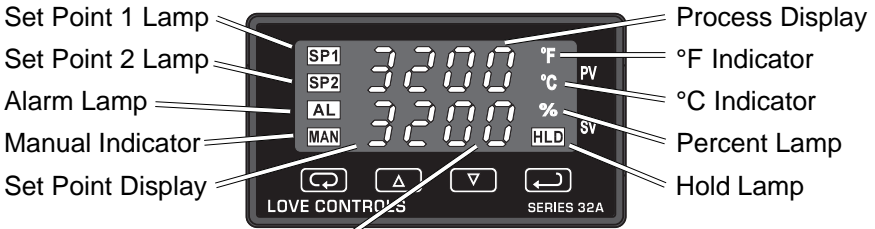

The decimal point flashes when Self-Tune is operating.

Keys are illuminated when pressed. Key functions are as follows:



INDEX: Pressing the INDEX key advances the display to the next menu item. May also be used in conjunction with other keys as noted below.



UP ARROW: Increments a value, changes a menu item, or selects the item to ON. The maximum value obtainable is 9999 regardless of decimal point placement.



DOWN ARROW: Decrements a value, changes a menu item, or selects the item to OFF. The minimum value obtainable is -1999 regardless of decimal point placement.



ENTER: Pressing ENTER stores the value or the item changed. If not pressed, the previously stored value or item will be retained. The display will flash once when ENTER is pressed.

UP ARROW & ENTER: Pressing these keys simultaneously brings up the **secondary menu** starting at the alarm, tune, or cycle item (depending on programming). Pressing these keys for 5 seconds will bring up the **secure menu**.

INDEX & DOWN ARROW: Pressing these keys simultaneously will allow backing up one menu item, or if at the first menu item they will cause the display to return to the **primary menu**. If an alarm condition has occurred, these keys may be used to reset the alarm. To reset an alarm press and hold both keys for three seconds.

INDEX & ENTER: Pressing these keys simultaneously and holding them for 5 seconds allows recovery from the various error messages. The following menu items will be reset:

ALiH: Alarm inhibit

OPEn InP: Input error message

bAd InP: Input error message

CHEC CAL: Check calibration error

Correct the problems associated with the above conditions before using these reset keys. More than one error could be present. Caution is advised since several items are reset at one time.

While in the **Primary or Secondary Menu**, if no key is pressed for a period of 30 seconds, the display will return to the HOME position displaying the

temperature value. While in the **Secure Menu**, if no key is pressed for a period of 60 seconds, the display will return to the HOME position displaying the temperature value. Outputs are disabled (turned off) when the **Secure Menu** is active.

NOTE: To move to the **Primary Menu** quickly from any other menu, press the **UP ARROW & ENTER** keys followed by pressing the **INDEX & DOWN ARROW** keys.

SECURITY LEVEL SELECTION

Four levels of security are provided. The display shows the current security level. To change security levels change the password value using the **UP & DOWN ARROW** keys and pressing the **ENTER** key. Refer to the password table (following) for the correct value to enter for the security level desired. The **SECr** menu item security level may be viewed or changed at any time regardless of the present security level.

To set the access level to, for example, **2**, at the **SECr** menu item press the **UP ARROW** key until the upper display show the password, **1101**. Press the **ENTER** key. The display will blink, and return with the level value, **2**, in the upper display.

The password values shown in the table cannot be altered, so retain a copy of these pages for future reference. This is the only reference made to password values in this instruction book.

PASSWORD TABLE

Menu	Security Level Status	Displayed Value When Viewed	Password Value To Enter
Primary Secondary Secure	Locked Locked Locked	1	1110
Primary Secondary Secure	Unlocked Locked Locked	2	1101
Primary Secondary Secure	Unlocked Unlocked Locked	3	1011
Primary Secondary Secure	Unlocked Unlocked Unlocked	4	111

NOTATION CONVENTIONS FOR THE MENUS

Because of the number of features available in this control, information is included that may not apply to your specific control. All usable features are included in this book, but may not be used in your process. To increase clarity the following conventions are used:

1. Certain features, Menu Items, and functions shown in this book may or may not appear on your control, depending on other Menu Item selections. At various places in the Menus there are notes identifying Menu Items that "control" or "direct" other menu items. If you are looking for a particular menu item and can't find it, check the menu item that is its "control" for proper setting.
2. The "#" symbol is used in two ways. It is used inside a group of characters to indicate which set point function (SP1 or SP2) is being affected. It is also used before a group of characters of a menu item to indicate that there may be more than one selection or value for that menu item. This is used for certain repeated items such as in the Ramp/Soak Program section.
3. *Features that apply only to Options will be printed in Italics.*

THE HOME DISPLAY

The home display is the normal display while the control is operating. If no errors or functions are active, the HOME display will indicate the Process Variable (the temperature, pressure, flow, RH, etc., that is being measured) on the top display and the Set Variable (Set Point 1) on the bottom.

Items that can change the HOME display are the Auto/Manual function, the **Prog** function, the **PctO** function, and any error message. Description of these special displays follow.

If Auto/Manual is enabled, the Manual indicator lights, and the home display is changed. The upper display continues to show the Process Variable (PV), but the lower display changes to show the percentage of output in tenths of a percent to 99.9% (0.0 to 99.9), or 100 if 100%. The display digit to the right of the number shows a flashing letter **o** to indicate that the value displayed is no longer the SV, but percent output. The SP2 output is indicated by the use of an overline on the letter **o**. Access to the SP2 value is done by the INDEX key. See Auto/Manual Operation on Page 13 for further information.

If **Prog** is turned **On**, the HOME display changes the SV display from SP1 to the Present Set Variable as calculated by the Ramp/Soak Programmer function. See Programming and Operation for Ramp/Soak Feature below for more information.

If **PctO** (Secondary Menu) is turned **On**, the lower display changes to show the active percentage of output as required to maintain SP1. The display is similar to the Auto/Manual display above, except that the letter indicators do not flash, and the output is displayed in whole percentages of output, not in tenths of a percent. If the control has both SP1 and SP2, the lower display will alternate between the SP1 percent output and the SP2 percent output.

Error messages are listed on Page 37 and 38.

PROGRAMMING AND OPERATION FOR RAMP / SOAK FEATURE

The ramp / soak feature offers a great deal of flexibility by allowing changes in the set point to be made over a predetermined period of time. Soak (dwell) times can be programmed, and the alarm output relay can be programmed to open or close during any of the segments.

Theory of Operation

The 32A Series controls offer a very simple approach to programming a ramp. Rather than requiring the operator to calculate an approach rate (usually in degrees per minute), the 32A does the calculation internally. Thus, the operator only needs to program the target set point and the time desired to reach that point. When the ramp segment is executed by the control, it calculates the ramp required to move the process from the starting value (current PV) to the desired value (programmed SP) in the time allowed.

Soaks (or dwells) are ramp segments where the target set point is the same as the beginning process value. This allows for multistage ramps without wasting intermediate soak steps. Care must be taken, however, that the process does actually reach the soak value before the soak time starts. If not, the next segment will calculate a slope from the starting PV to the target SP. Depending on your process requirements, this difference may be important. Make sure to test any program for desired results before running production material.

Do not operate Self Tune while a ramp function is operating. The ramp function will prevent the Self Tune from operating properly. Make sure that all tuning is set up before operating Ramp / Soak.

Program Setup

All of the programming for the Ramp / Soak function is done in the Secondary Menu. You may wish to work out your program on paper before going into the programmer menu sequence.

In the Secondary Menu INDEX to **Prog** and make sure that **Prog** is set to **OFF**.

INDEX to **PSEt** and turn **On**.

Skip the **StAt** setting (this is discussed later) and press INDEX to **1ti**.

The following items repeat in the following order: **1ti**, **1SP**, **1AL** (if alarm is programmed as an event), **2ti**, **2SP**, **2AL**, . . . , **16ti**, **16SP**, **16AL**. To avoid repetition each item will only be described once.

Set **1ti** to the amount of time you want for the first ramp. This value is in time units (determined by the **tbAS** menu item) from **0** to **9999**. Press INDEX

Set **1SP** to the target value desired for the first ramp. This value is in actual units just like **SP1**. If the control is programmed for temperature, then the SP displays are in temperature. If the control is programmed for some other engineering unit, the SP is set in that unit.

Press INDEX to continue. If Alarm is programmed as an event, then **1AL** will appear. If you wish the Alarm contact to function for this segment, set **1AL** for **On**. If not, set for **OFF**. Press INDEX. If Alarm is not programmed as an event, then **1AL** will not appear. If **1AL** is set to **On**, the Alarm function will be active for the entire period as set in **1ti** above.

Complete setting the segment times (**2ti ... 16ti**), segment set points (**2SP ... 16SP**), and event alarm (**2AL ... 16AL**) if it exists.

For unneeded or unused segments set the segment times (**2ti ... 16ti**) to **0**, and set the segment set points (**2SP ... 16SP**) to the same value as the last active set point. Event alarms may be set to indicate "end of run" as you feel necessary.

The last menu item for the ramp / soak function is **PEnd**. **PEnd** determines what the control does when the program has ended. You may choose to have the program repeat (**LooP**), **Hold** the last set point (**16SP**), revert to the local **SP1**, or turn the outputs off (**OoFF**).

It is important to remember that if you want the program to repeat, you must allow the process to return to the same condition that existed when the program first started. Remember that the ramp function calculates the slope by drawing a line from the beginning PV to the ramp target set point. If the PV at the end of the program is different than the PV at the initial start, the ramp will calculate differently.

Ramp / Soak Operation

When you wish to start the program, enter the Secondary Menu and set the **Prog** menu item to **On**. Return to the HOME position by waiting for the display to time out or by pressing the UP ARROW / ENTER keys and then the DOWN ARROW / INDEX keys.

The home display will read as it normally does. The HOLD indicator over the RUN / HOLD key will be lit. To start the program press INDEX to display **Prog**. Press the UP ARROW key to select **run** and press ENTER. The HOLD indicator will go out, and the program will start.

To suspend the program at any time, INDEX to **Prog**, press the DOWN ARROW key to display **HOLd**, and press ENTER. To resume, INDEX to **Prog**, press the UP ARROW to select **run**, and press ENTER.

Entering the AUTO / MANUAL mode will also suspend the program operation. The difference is that AUTO / MANUAL also puts the control into manual mode. See Auto / Manual Operation below.

The function of the Primary Menu will change depending on the setting of the **StAt** menu item in the Secondary Menu. If **StAt** is **OFF** then the Primary Menu is not changed.

If the **StAt** menu item is set to **On**, then the Primary Menu has three additional information items added before **SP1** appears. The first INDEX item, **####/ ti**, displays the time remaining in the current segment. The next INDEX item, **####/##ti**, displays the total time for the active segment (**1ti...16ti**). The third INDEX item, **####/##SP**, displays the segment set value (**1SP...16SP**). The next INDEX press resumes the normal Primary Menu

AUTO / MANUAL OPERATION

The AUTO / MANUAL function allows you to manually adjust the output of the control. This is normally used during process setup or start up. It can also be used for troubleshooting. To switch from AUTO to MANUAL press INDEX to **Auto**. Press the UP ARROW to select **OFF** and press ENTER. The MANual indicator will light and the lower display will change from normal to showing the actual output in percent. The value will be the actual percentage of output that was active when the key was pressed. This is usually known as "bumpless transfer".

If you wish to change the output while in manual, press the UP ARROW or DOWN ARROW keys to change the value, and press ENTER to retain it. It

is important to remember that the value of the display can be read as 0 to 100% of the full control output, or 0 to 100% of the range between **S1OL** and **S1OH** or **S2OL** and **S2OH**. If **APct** is set for **rEAL**, a reading of 50% in **MANUAL** represents 10 mA. If **APct** is set for **AdJ**, then 50% in **MANUAL** will represent the mid point in output between **S1OL** and **S1OH**. (Assuming **S1OL** is **20** and **S1OH** is **100** [4 to 20 mA], 50% will represent 12 mA.)

To return to **AUTOMatic** control, press the **ENTER** until **Auto** is displayed. Press the **DOWN ARROW** key to **On**, and press **ENTER**. The **MANual** indicator will go out, and the set point will take over. If you want bumpless transfer back to **AUTO**, while in manual, slowly change the percentage of output until the process variable matches (or at least is close) to the set point. The further away the **PV** is from the set point, the greater the "bump" or upset there will be in the output.

OPERATION OF SELF TUNE® FUNCTION

Self Tune® allows automatic selection of the necessary parameters to achieve best control operation from your 32A Series control. If you are using the control output as a simple on-off function (**Out1** set for **OnOF**), none of the following will apply.

Theory of Operation

The Self Tune function calculates the **Pb1**, **rES**, and **rtE** parameters under the **PID tunE** selection, and the **Fbnd** and **FrE** parameters, as shown in the Secondary Menu . These values are determined by measuring the response of the process connected to the control. When Self Tune is started, the control temporarily acts as an on-off control. While in this mode the control measures the overshoot and undershoot of the process, and the period of the process (the time from peak value to the next peak value). These measurements are collected over a period that lasts three periods of overshoot and undershoot. The data collected over this time is then compared and calculated into final PID and Fuzzy Logic values. The effect of Fuzzy Logic on the process is still controlled by the **Fint** (fuzzy intensity) setting. If **Fint** is **0**, the **Fbnd** and **FrE** will be calculated, but will have no effect. The calculations for the PID values are the same as used in the standard Ziegler - Nichols equations that have been recognized as standard for decades.

The only modification to the application of the Ziegler - Nichols equations is controlled by the **dfAC** menu item. This menu item controls the amount of rate (derivative) that is applied. A **dfAC** setting of **3** (factory default) or less allows for less damping. A **dfAC** setting of **4** allows for critical damping as set forth in Ziegler - Nichols. A **dfAC** setting of **5** or more allows over damping of the process.

Program Setup and Operation

In the secondary menu set **tunE** to **SELF**. Skip **LErn** and check to make sure that **dFAC** is set to the desired value. Back up to **LErn** and set to **YES**. The control will begin the Self Tune function. While the Self Tune function is active, the right hand decimal point on the lower display will blink. When Self Tune is complete, the blinking will stop.

After Self Tune is complete, the **tunE** setting automatically switches to **PID**. This allows examination and / or modification of the values calculated. We recommend that you do not change the calculated values unless you have a firm understanding of the parameters involved and their function. For more information on PID tuning, please contact your supplier.

OPERATION AND PROGRAMMING OF OPTIONS

Options 924, 926, 928, Analog Remote Set Point

The analog remote set point allows the control set point to be determined by an outside analog signal. The signal may be 0 to 10 VDC (Option 924), 0 (or 4) to 20 mADC (Option 926), or 0 to 10,000 Ohms (Option 928).

Wire the input as shown on page 6.

To set up the analog remote set point, first determine the scale range that the analog signal will represent. The maximum span is 11,998 degrees or counts. In the Secure Menu set **rSCL** for the scale value that will be represented by the low end of the analog signal (0 Volts, 0 mA, 0 Ohms). Set **rSCH** for the scale value that will be represented by the high end of the analog signal (10 Volts, 20 mA, 10,000 Ohms).

If you require a suppressed scale or input, you may use the following equations to determine the proper settings for **rSCL** and **rSCH**.

$$K = \frac{\text{Highest desired scale reading} - \text{Lowest desired scale reading}}{\text{Maximum desired analog signal} - \text{Minimum desired analog signal}}$$
$$rSCH = ((\text{Maximum possible analog signal} - \text{Maximum desired analog signal}) * K) + \text{Highest desired analog reading}$$
$$rSCL = \text{Lowest desired scale reading} - ((\text{Minimum desired analog signal}) * K)$$

Operation is simple. Make sure that a valid analog signal is available to the control. In the Secondary Menu set the **rSPt** to **On**. The REM indicator on the front of the control will turn on. When the control returns to the HOME position, the displayed SV will be the value supplied from the analog remote signal. If the analog remote signal fails or goes out of range of the **SPL** or **SPH** settings, the control will revert to the internal **SP1** (or **#SP1**), and flash the error message

CHEC rSPt. If **SPL** or **SPH** are set outside of **rSCL** or **rSCH** then the error will be suppressed, and the control will attempt to work with the remote value.

To clear the error message, change **rSPt** to **OFF**.

Option 934, 936, Isolated Analog Retransmission.

The analog retransmission option allows the Process Variable or the Set Variable to be sent as an analog signal to an external device. The signal may be either 0 to 10 VDC (Option 936) or 0 (or 4) to 20 mADC (Option 934). The output may be changed in the field from one to the other by the toggle switch located on the top printed circuit board.

Wire the output as shown on page 6.

To set up the analog retransmission, first determine the scale range that the analog signal will represent. The maximum scale is 9999°F, 5530°C, or 9999 counts. In the Secondary Menu set **POL** for the scale value that will be represented by the low end of the analog signal (0 Volts or 0 mA). Set **POH** for the scale value that will be represented by the high end of the analog signal (10 Volts or 20 mA).

If you require a suppressed scale or output, you may use the following equations to determine the proper settings for **POL** and **POH**.

$K = \frac{\text{(Highest desired scale reading - Lowest desired scale reading)}}{\text{(Maximum desired analog signal - Minimum desired analog signal)}}$

$POH = \text{(Maximum possible analog output - Maximum desired analog signal)} * K + \text{Highest desired analog reading.}$

$POL = \text{Lowest desired scale reading - ((Minimum desired analog output) * K).}$

Next select whether you want the retransmission signal to follow the Process Variable or the Set Variable. Usually the Process Variable is sent to recorders or other data acquisition devices. Usually the Set Variable is sent to other controls to be used as an analog remote set point. If you want the analog retransmission signal to follow the PV, in the Secondary Menu set **POSr** to **InP**. If you want the analog retransmission signal to follow the SV, set **POSr** to **SPT**.

Operation is automatic. There are no further programming steps required.

Option 948, 2-Stage Set Point.

The 2-stage set point option allows two different values to be used for **SP1** and all of the values associated with the **tunE** menu items. The control will switch to a given stage when an external contact is made or opened across the

appropriate terminals at the rear of the control (when **SPSA**, Set Point Switch Action, is set for remote, **rE**), or when the stage is selected from the Secondary Menu, **SP** (when **SPSA** is set for **Int**). When the state of a contact changes (or the stage number is changed in the Secondary Menu), the values in use are stored and the previously stored values for the new stage are used.

Wire the input as shown on page 6.

Usually the control is configured for external switching of the stages. In this case, the operation is usually automatic, selected by the external switches driven by the machine logic. If it is necessary to program the stages in advance, you may select the stage to modify with the **SP** menu item. When **SP** is changed while the **SPSA** is set for **rE**, the selected stage is displayed for modification, but only used when the appropriate contact is made.

Option 992, Serial Communication.

The serial communications option allows the control to be written to and read from a remote computer or other similar digital device. Communication is allowed either through a RS-485 (Option 992) port.

Wire the communication lines as shown on Page 6. Wiring for the RS-485 is run from control to control in a daisy chain fashion with a termination resistor (120 ohms) across the transmit and receive terminals of the last control in the chain.

Select the control address and communication baud rate with the **Addr** and **bAud** menu items in the Secure Menu. THE BAUD RATE AND ADDRESS MENU ITEMS WILL TAKE EFFECT ON THE NEXT POWER UP OF THE CONTROL. BE SURE TO POWER CYCLE THE CONTROL BEFORE USING THE NEW BAUD RATE AND ADDRESS.

In operation, you have the option of preventing a write command from the host computer. To prevent the host from writing to the control change the **LORe** menu item in the Secondary Menu to **LOC**. To allow the host to write commands to the control set **LORe** to **rE**. (The host does have the ability to change the **LORe** state, but it is not automatic.)

If your system depends on constant reading or writing to and from the host, you may wish to set the No Activity Timer (**nAt**) to monitor the addressing of the control. When the **LORe** is set to **rE** and the **nAt** is set to any value other than Off, the control will expect to be addressed on a regular basis. If the control is not addressed in the time set by the value of **nAt**, then the control will display the error message **CHEC LORe**. To clear the message set **LORe** to **LOC**.

CHANGING PROGRAMMING FOR SET POINT 2 AND ALARM

Either Set Point 2 or the Alarm function as the second output of the 32A. The ordering code determines whether the second output operates as a second set point or alarm.

When the 32A second output is programmed as **Control**, **SP2** appears in the Primary Menu and the appropriate **SP2** related menu items appear in the Secondary and Secure Menus. When the 32A second output is programmed as **ALarm**, the alarm related menu items appear in the Secondary and Secure Menus.

If you have a control with a second output and wish to change the function of the second output from **ALarm** to **Control** (or vice versa) use the Factory Default procedure.

FACTORY DEFAULT PROCEDURE

If for any reason you wish to restore the factory settings or change the function of the second output between **ALarm** or **Control** follow the following procedure.

1. Turn off power to control
2. Turn on power to control
3. While control is performing **SELF tESt**, press and hold the INDEX and ENTER keys.
4. The control will display the ROM ID code. Press INDEX.
5. The control will display **FAcT dFLt**. If you wish to just restore factory settings, Press ENTER and DOWN ARROW at the same time. The control will be reset to the original factory settings.
6. If you wish to change the operation of the second output, press INDEX.
7. Press INDEX to display **SP2**. Select **Cont** or **AL**.
 - Cont** Uses **SP2** menu items for second output.
 - AL** Uses **ALarm** menu items for second output.
8. Press INDEX to display **OPt**. If your control is equipped with an option, press the UP ARROW to display the option number. If the number is flashing, press ENTER. An enabled option does not flash. If you wish to use the 2-stage set point option 948 without the external switch closure, this option may be enabled for internal only operation on any control.
9. Press INDEX to display **ACPt**. Select **YES** or **no**.
 - YES** Changes are accepted and control re-boots.
 - no** Changes are discarded and control re-boots.

ALARM TYPE AND ACTION



Caution: In any critical application where failure could cause expensive product loss or endanger personal safety, a redundant limit controller is required.

The 32A Series allows Set Point 1 (and Set Point 2 is equipped) to operate as limit or alarm type outputs. This function is available on all outputs except the proportional current (output type 5). To enable a set point output to act as an alarm or limit, **Out1** (for SP1) or **Out2** (for SP2, if equipped) should be set for **OnOf**.

When **Out1** and / or **Out2** are set to **OnOf**, then the alarm function menu items will appear in the Secure Menu for the selected set point(s).

If the Alarm Programming code in the model number is set to 1, then set point 2 is pre-programmed as an alarm. If the alarm Programming code in the model number is set to 0 and the last number of the model number is not 0 then the second set point is pre-programmed as a cooling output. This programming may be changed in the field with the Factory Default procedure on the previous page..

When setting **SP2** value (**S2t = AbS**) or the **ALLO** and **ALHi** values (**ALt = AbS**) for an absolute alarm, simply set the value at which the alarm is to occur.

When setting **SP2** value (**S2t = dE**) or the **ALLO** and **ALHi** values (**ALt = dE**) for a deviation alarm, set the difference in value from the Set Point 1 (**SP1**) desired. For example if a low alarm is required to be 5 degrees below the **SP1**, then set **SP2** or **ALLO** to **-5**. If a high alarm is required 20 degrees above the **SP1**, then set **SP2** or **ALHi** to **+20**. If **SP1** is changed, the alarm (**SP2, ALLO, ALHi**) will continue to hold the same relationship as originally set.

When Set Point Power Interrupt (**S#Pi**) or Alarm Power Interrupt (**ALPi**), is programmed **ON** and Set Point Reset (**S#rE**) or Alarm Reset (**ALrE**), is programmed for **Hold**, the alarm will automatically reset after a power failure and on subsequent power restoration if no alarm condition is present.

If Set Point Inhibit (**S#iH**) or Alarm Inhibit (**ALiH**), is selected **ON**, an alarm condition is suspended upon power up until the process value passes through the alarm set point once. Alarm inhibit can be restored as if a power up took place by pressing both the **INDEX** and **ENTER** keys for 5 seconds.



Warning: Resetting a high set point inhibit will not cause an alarm to occur if the Process Value does not first drop below the high set point value. Do not use the Set Point Inhibit feature if a hazard is created by this action. Be sure to test all combinations of high and low set point inhibit actions before placing control into operation.

MENU SELECTIONS

PRIMARY MENU

Press **INDEX** to advance to the next menu item. Press **UP ARROW** or **DOWN ARROW** to change the value in the display. Press **ENTER** to retain the value.

If **StAt** (Secondary Menu) is **On**, the three program status menu items will appear.

ti Time remaining for current segment.

##ti Total run time for segment ##.

##SP Target Set Point for segment ##.

If **StAt** (Secondary Menu) is **OFF**, the Primary menu operates as follows:

#SP1 (*Option 948, 2-Stage Set Point*) or
SP1 Set Point 1 Adjust, Control Point 1.

SP2 Set Point 2 Adjust (if equipped), Control Point 2.

Auto Auto/Manual Station, Select **On** or **OFF**.

On Output operation is automatic (normal operation).

OFF Output is controlled manually.

See Page 13 for operation of Auto/Manual Station Feature.

If **Prog** is **OFF** in the Secondary Menu, **Prog** (below) will not appear.

Prog Ramp/Soak Programmer Run/Hols function, Select **run** or **HoLd**.

run Ramp/Soak Programmer is in operation.

HoLd Ramp/Soak Programmer is on hold.

SECONDARY MENU

Hold **UP ARROW & ENTER**. Press **INDEX** to advance to the next menu item. Press **UP ARROW** or **DOWN ARROW** to change the value in the display. Press **ENTER** to retain the value.

If the control is not equipped with alarm, or if the alarm functions (**AL**) are turned **OFF** or programmed as event (**Eunt**), **ALLO** and **ALHi** will not appear.

ALLo Alarm Low: The Low Alarm point is usually set below the Set Point. May not appear depending on **AL** setting in **Secure Menu**.

ALHi Alarm High: The High Alarm Point is usually set above the Set Point. May not appear depending on **AL** setting in **Secure Menu**.

Out1 Output selection: Select **OnOf**, **1tP**, **1PuL**, or **ProP**.

ONOF A setting of **ONOF** allows the control to operate as a simple on/off mode. This setting forces the control to turn off at set point, and on at the set point plus the differential (**SP_d**). When selected, the **Out1/OnOF** menu item is followed by **####/SP1d**, and the **tunE**, **Pb**, **rES**, **OFS**, **rtE**, and **ArUP** selections in the Secondary menu and the **S1OL** and **S1OH** selections in the Secure menu are suppressed.

SP_d Set Point On-Off Differential (hysteresis). Select **1** to **9999** (direct acting), or **-1** to **-9999** (reverse acting). This value will be negative for reverse acting set points, and positive for direct acting outputs. Set the value for the amount of difference between the turn off point (set point) and the turn on point. The following drawing shows output behavior for reverse and direct action.

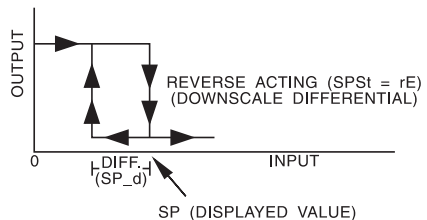
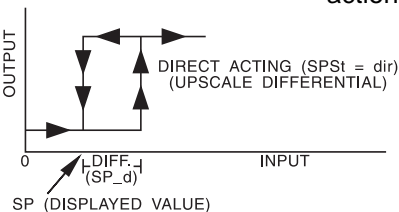

##tP Time Proportioning Cycle Time. Select **1tP** to **80tP**.

1tP A setting of **1tP** is recommended for solid state outputs (SSR or 15VDC).

2tP to 80tP Time Proportioning Control is adjustable in 1 second steps. Recommended for me-

chanical outputs (relays, solenoids, etc.). For best contact life, a time should be selected as long as possible without causing the process to wander.

#PuL Pulsed Time Proportioning Output: Select **1PuL** to **7PuL**. **1PuL** = Linear and **7PuL** = most nonlinear. Changes output linearity for use in cooling applications or for an extremely fast response processes. At the center of the proportional band, a pulse value of 1 provides an output of one second on and one second off (50% output). A pulse value of 2 provides an output of one second on and two seconds off (33% output). Output at center of band equals one second on, $2^{(\text{pulse value}-1)}$ seconds off.

ProP For Current (Code 5) outputs only.

The following menu items apply only if your control is equipped with a second set point (last digit of model number is not zero and Alarm Programming code is zero). If your control does not have a second set point or if the second output is programmed as Alarm, jump to the "tunE" menu on the next page.

Out2 Output selection: Select **OnOf**, **2tP**, **2PuL**, or **ProP**.

ONOF A setting of **ONOF** allows the control to operate as a simple on/off mode. This setting forces the control to turn off at set point, and on at the set point plus the differential (**SP2d**). When selected, the **Out2/OnOf** menu item is followed by **####/SP2d**, and the **Pb2** selection in the Secondary menu and the **S2OL** and **S2OH** selections in the Secure menu are suppressed.

SP2d Set Point On-Off Differential (hysteresis). Select **1** to **9999** (direct acting), or **-1** to **-9999** (reverse acting). This value will be negative for reverse acting set points, and positive for direct acting outputs. Set the value for the amount of difference between the turn off point (set point) and the turn on point. The drawing on the previous page (See **SP1d**) shows output behavior for reverse and direct action.

##tP Time Proportioning Cycle Time. Select **1tP** to **80tP**.

1tP A setting of **1tP** is recommended for solid state outputs (SSR or 15VDC).

2tP to 80tP Time Proportioning Control is adjustable in 1 second steps. Recommended for me-

chanical outputs (relays, solenoids, etc.). For best contact life, a time should be selected as long as possible without causing the process to wander.

#PuL Pulsed Time Proportioning Output: Select **1PuL** to **7PuL**. **1PuL** = Linear and **7PuL** = most nonlinear. Changes output linearity for use in cooling applications or for an extremely fast response processes. At the center of the proportional band, a pulse value of 1 provides an output of one second on and one second off (50% output). A pulse value of 2 provides an output of one second on and two seconds off (33% output). Output at center of band equals one second on, $2^{(\text{pulse value}-1)}$ seconds off.

SP (Option 948, 2-Stage Set Point) Active Set Point Stage. Select **1SP1** or **2SP1**. (See Page 17 for more detail.)

1SP1 Set Menu Items to display Stage 1 for view and change access. If **SPSA** is set for **Int**, **1SP1** is made active.

2SP1 Set Menu Items to display Stage 2 for view and change access. If **SPSA** is set for **Int**, **2SP1** is made active.

#SP1 (Option 948, 2-Stage Set Point) Adjust Control Point 1 for Stage selected above.

Note: The menu items for **tunE** (below) are modified when Option 948 is in use. When Option 948 is active the menu items are preceded with the stage number selected in **SP** above. The stage number is noted here with the # sign. When the 2 Stage Set Point option (948) is active, each stage has its own set of **tunE** parameters.

#tun tunE (Option 948, 2-Stage Set Point) or Tuning Choice: Select **SELF**, **Pid**, **SLO**, **nor**, or **FASt**.

SELF The Controller will evaluate the Process and select the PID values to maintain good control. Active for SP1 only.

LErn Select **YES** or **no**

YES Start Learning the Process. After the process has been learned the menu item will revert to **no**.

no Learning will stay in present mode.

dFAC Damping factor, Select **OFF**, **1** to **7**. Sets the

ratio of Rate to Reset for the SELF tunE mode.
7 = most Rate. Factory set to **3**. For a fast response process the value should be lowered (less Rate). For a slower process the value should be increased (more Rate).

Pid Manually adjust the PID values. PID control consists of three basic parameters, Proportional Band (Gain), Reset Time (Integral), and Rate Time (Derivative).

#Pb1 (Option 948, 2-Stage Set Point) or
Pb1 Proportional Band (Bandwidth). Select **1** to **9999** °F, °C, or counts.

Pb2 Proportional Band (Bandwidth). Select **1** to **9999** °F, °C, or counts. Appears only if control is equipped with second set point and **Out2** is NOT selected as **ONOF**.

#rES (Option 948, 2-Stage Set Point) or
rES Automatic Reset Time. Select **OFF**, **0.1** to **99.9** minutes. Select **OFF** to switch to **OFS**.

#OFS (Option 948, 2-Stage Set Point) or
OFS Manual Offset Correction Select **OFF**, **0.1** to **99.9%**. Select **OFF** to switch to **rES**.

#rtE (Option 948, 2-Stage Set Point) or
rtE Rate Time. Select **OFF**, **0.01** to **99.99** minutes, Derivative.

SLO PID values are preset for a slow response process.
nor PID values are preset for a normal response process.
FAST PID values are preset for a fast response process.

Pid2 Linkage of PID parameters between SP1 and SP2: Select **On** or **OFF**.

On Applies SP1 **rEs**, **rtE**, **Fbnd**, and **Frte** terms to SP2 for heat/cool applications.

OFF SP2 functions without **rEs**, **rtE**, **Fbnd** and **Frte**. Does not appear if not equipped with second output or if second output is programmed as alarm.

ArUP Anti- Reset Windup Feature: Select **On** or **OFF**.

On When ArUP is **On** the accumulated Reset Offset value will be cleared to 0% when the process input is not within the Proportional Band.

OFF When ArUP is **OFF**, the accumulated Reset Offset Value is retained in memory when the process input is not within the Proportional Band.

- ArtE** Approach Rate Time: Select **OFF**, **0.01** to **99.99** minutes. The function defines the amount of Rate applied when the input is outside of the Proportional Band. The ArtE time and the rtE time are independent and have no effect on each other. To increase damping effect and reduce overshoot set the approach rate time for a value greater than the natural rise time of the process (natural rise time = process value time to set point).
- Fint** Fuzzy Logic Intensity: Select **0** to **100%**. 0% is OFF (disables Fuzzy Logic). The function defines the amount of impact Fuzzy Logic will have on the output. If **Fint** is set to **0**, **Fbnd** and **Frte** below will not appear.
- Fbnd** Fuzzy Logic Error Band: Select **0** to **4000** °F, °C, or counts. Sets the bandwidth of the Fuzzy Logic. Set **Fbnd** equal to PID proportional band (**Pb1**) for best results. Will not appear if **Fint** is **OFF**.
- Frte** Fuzzy Logic Rate of Change: Select **0.00** to **99.99** counts/second. For best initial setting, find the count/second change of process value near set point 1 with output ON 100%. Multiply this value by 3. Set **Frte** to this calculated value. Will not appear if **Fint** is **OFF**.
- PEA** The Peak feature stores the highest input the control has measured since the last reset or Power On. At Power On PEA is reset to the present input. To manually reset the value **PEA** must be in the lower display. Press the **ENTER** key to reset. **PEA** will be reset and display the present input value.
- UAL** The Valley feature stores the lowest input the Instrument has measured since the last reset or Power On. At Power On **UAL** is reset to the present input. To manually reset the value **UAL** must be in the lower display. Press the **ENTER** key. **UAL** will be reset and display the present input value.
- PctO** Percent Output Feature: Select **On** or **OFF**.
- On** When selected **On**, the HOME lower display will indicate the output of the controller in percent. An "o" will appear in the right hand side of the lower display to indicate percent output for SP1. An "o" will appear on the right hand corner of the lower display to represent percent output for SP2, if the control is so equipped. The display will alternate between these values.
- OFF** Percent Output display is disabled.

- Prog** Ramp/Soak Feature: Select **On** or **OFF**
On Allows Programmed Ramp/Soak function to be started by the Run/Hold key on the control front panel.
OFF Turns Ramp/Soak function **OFF** and resets program to beginning.
- PSEt** Programmer function set. Select **On** or **OFF**.
Off Skip Ramp/Soak Programming. Go to next Secondary Menu Item, InPC on the next page.
On Enable Ramp/Soak Programming.
- StAt** Programmer Status Display in the Primary Menu when Prog (above) is On: Select **On** or **OFF**.
OFF The Primary Menu operates as normal.
On The Primary Menu is altered to have the following items inserted before the SP1 menu item: **####/ti** (time remaining in segment), **####/##ti** (total time in active segment), and **####/##SP** (segment target set point).
- tbAS** Ramp/Soak Time Base. Select **1_S** or **60_S**.
1_S Ramp/Soak time base is in 1 second increments. Program time 1ti...16ti is measured in seconds.
60_S Ramp/Soak time base is in 60 second increments (minutes). Program time 1ti...16ti is measured in minutes.

The following items repeat in the following order: 1ti, 1SP, 1A1 (if alarm 1 is programmed as an event), 2ti, 2SP, 2A1, . . . , 16ti, 16SP, 16A1. To avoid repetition each item will only be described once.

- 1ti** Segment Time: Select **0** to **9999** units (minutes if **tbaS** is set to **60_S**, seconds if **tbaS** is set to **1_S**).
- 1SP** Segment Set Point: Select as desired.
- 1AL** Segment Alarm Event: Select **On** or **OFF** .
On Alarm is active during segment 1 time (**1ti**).
OFF Alarm is inactive during segment 1 time (**1ti**).
- PEnd** Program End action: Select **Hold** or **OoFF**.
Hold Stay at the Present Set Point (**16SP**).
OoFF Turn Off SP1 and SP2 Outputs at the end of the program.

Loop Repeat program starting at **1ti**.
SP1 Revert to **SP1** value.

InPC Input Correction: Select **±500** °F, °C, or counts. This feature allows the input value to be changed to agree with an external reference or to compensate for sensor error. **Note:** InPC is reset to zero when the input type is changed, or when decimal position is changed.

FiLt Digital Filter: Select **OFF, 1** to **99**. In some cases the time constant of the sensor, or noise could cause the display to jump enough to be unreadable. A setting of 2 is usually sufficient to provide enough filtering for most cases, (2 represents approximately a 1 second time constant). When the 0.1 degree resolution is selected this should be increased to 4. If this value is set too high, controllability will suffer.

LPbr Loop Break Protection: Select **OFF, 1** to **9999** seconds. If, during operation, the output is minimum (0%) or maximum (100%), and the input moves less than 5°F (3°C) or 5 counts over the time set for LPbr, the **LOOP bAd** message will appear. This condition can also be routed to an Alarm Condition if alarms are present and turned On (see ALbr in the secure menu). The loop break error can be reset by pressing the **ENTER** key when at the LPbr menu item. The **INDEX & ENTER** keys may also be used.

POL *(Option 934, 936, Analog Retransmission Output) Process Output Low: Select -450°F, -260°C, or -1999 counts to any value less than **POH**.*

POH *(Option 934, 936, Analog Retransmission Output) Process Output High: Select from any value greater than **POL** to +9999°F, +5530°C, or 9999 counts.*

POSr *(Option 934, 936, Analog Retransmission Output) Process Output Source: Select **InP** or **SPt**.*

InP Process output follows the Process Variable (input).

SPt Process Output follows the Set Variable (SP1).

rSPt *(Option 924, 926, 928, Analog Remote Set Point) Remote Set Point: Select **On** or **OFF**.*

OFF The control uses the value set for **SP1**.

On The control uses the value set by the analog remote set point signal as established by the Secure Menu items **rSCL** and **rSCH**. If the analog signal fails, the control will

display the error message **CHEC/LorE** and revert to the **SP1** local value.

LOrE (Option 992, Serial Communications) Local / Remote Status: Select **LOC** or **rE**.

LOC The host computer is advised not to send remote commands. Any write commands sent to the controls will be rejected.

rE The host computer is allowed to send write commands. If the control is not addressed within the time set in the **nAt** (No Activity Timer, see Secure Menu) the **CHEC LorE** error message will be displayed.

Addr (Option 992, Serial Communications) Control Address: Set from 1 to 3FF. This number (hexadecimal, base 16) must match the address number used by the host computer. Viewed only in this menu. To change this parameter, see **Addr** in the Secure Menu.

SECURE MENU

Hold **UP ARROW & ENTER** for 5 Seconds. Press **INDEX** to advance to the next menu item. Press **UP ARROW** or **DOWN ARROW** to change the value in the display. Press **ENTER** to retain the value.

OUTPUTS ARE DISABLED (TURNED OFF) WHILE CONTROL IS IN SECURE MENU.

SECr Security Code: See the Security Level Selection and the Password Table in this manual, in order to enter the correct password.

InP Input Type: Select one of the following. Refer to the Input wiring section for the proper wiring.

J-IC Type "J" Thermocouple

CA Type "K" Thermocouple

E- Type "E" Thermocouple

t- Type "T" Thermocouple

L- Type "L" Thermocouple

n- Type "N" Thermocouple

r-13 Type "R" Thermocouple

S-10 Type "S" Thermocouple

b- Type "B" Thermocouple

C- Type "C" Thermocouple

P392 100 ohm Platinum (NIST 0.00392 $\Omega/\Omega/^\circ\text{C}$)

n120 120 ohm Nickel

P385 100 ohm Platinum (DIN 0.00385 $\Omega/\Omega/^\circ\text{C}$)

1P38 1000 ohm Platinum (DIN 0.00385 $\Omega/\Omega/^\circ\text{C}$)

Curr DC Current Input 0.0 to 20.0 or 4.0 to 20.0 mA.

VoLt DC Voltage Input 0.0 to 10.0 or 2.0 to 10.0 volts.
diFF DC Voltage Input -10 to +10 mV.
---- Reserved

OSUP Zero Suppression: Select **On** or **OFF**. Only with Current and Voltage input types.

OFF The input range will start at 0 (zero) Input.

On The input range will start at 4.00 mA or 2.00 V.

Unit **F, C** or **None**.

F °F descriptor is On and temperature inputs will be displayed in actual degrees Fahrenheit.

C °C descriptor is On and temperature inputs will be displayed in actual degrees Celsius.

none °F and °C descriptors will be Off. This is only available with Current and Voltage Inputs.

dPt Decimal Point Positioning: Select **0, 0.0, 0.00, or 0.000**. On temperature type inputs this will only effect the Process Value, SP1, SP2, ALLo, ALHi, and InPC. For Current and Voltage Inputs all Menu Items related to the Input will be affected.

0 No decimal Point is selected. This is available for all Input Types.

0.0 One decimal place is available for Type J, K, E, T, L, RTD's, Current and Voltage Inputs.

0.00 Two decimal places is only available for Current and Voltage Inputs.

0.000 Three decimal places is only available for Current and Voltage inputs.

InPt Input Fault Timer: Select **OFF, 0.1** to **540.0** minutes. Whenever an Input is out of range (UFL or OFL displayed), shorted, or open the timer will start. When the time has elapsed, the controller will revert to the output condition selected by **InPb** below. If OFF is selected, the Input Fault Timer will not be recognized (time = infinite).

InPb Input Fail Action: Select **FAIL, AVE,** or **PrE**. When the Input is out of range (UFL or OFL displayed) and the Input timer (**InPt**) time has elapsed, the controller will revert to the selected condition.

FAIL Outputs are disabled (go to 0% output).

AVE The outputs will hold at the last known average percentage of output.

PrE The outputs will maintain a preprogrammed percentage

of output as specified in **PrE1** and **PrE2**.

PrE1 Preset output for Set Point 1. Select 0 to 100%.

PrE2 Preset output for Set Point 2. Select 0 to 100%.

- APCt** Manual and PctO display adjustment. Select **rEAL** or **AdJ**.
- rEAL** Manual display will display output 0 to 100% relative to actual range of the output.
- AdJ** Manual display will display output 0 to 100% relative to the **S#OL** and **S#OH** settings.
- SEnC** Sensor Rate of Change: Select **OFF**, **1** to **4000** °F, °C, or counts per 1 second period. This value is usually set to be slightly greater than the fastest process response expected during a 1 second period, but measured for at least 2 seconds. If the process is faster than this setting, the **SEnC bAd** error message will appear. The outputs will then be turned off. This function can be used to detect a runaway condition, or speed up detection of an open thermocouple. Use the **INDEX & ENTER** keys to reset.
- SCAL** Scale Low: Select **100** to **9999** counts below **SCAH**. The total span between **SCAL** and **SCAH** must be within 11998 counts. Maximum setting range is -1999 to +9999 counts. For Current and Voltage inputs, this will set the low range end. Viewable only for Thermocouple and RTD ranges.
- SCAH** Scale High: Select **100** to **9999** counts above **SCAL**. The total span between **SCAL** and **SCAH** must be within 11998 counts. Maximum setting range is -1999 to +9999 counts. For Current and Voltage inputs, this will set the high range end. Viewable only for Thermocouple and RTD ranges.
- SPL** Set Point Low: Select from the lowest input range value to **SPH** value. This will set the minimum SP1 or SP2 value that can be entered. The value for SP1 or SP2 will not stop moving when this value is reached. *If equipped with option 924 or 926, if **SPL** is set above **rSCL** then control will revert to **SP1** if remote value goes below **SPL**.*
- SPH** Set Point High: Select from the highest input range value to **SPL** value. This will set the maximum SP1 or SP2 value that can be entered. The value for SP1 or SP2 will not stop moving when this value is reached.. *If equipped with option 924 or 926, if **SPH** is set below **rSCH** then control will revert to **SP1** if remote value goes above **SPH**.*

SP1O Set Point 1 Output Select: Select **OutA** or **Outb**.
OutA Set Point 1 is routed through Output A, Set Point 2 (if equipped) is routed through Output B. Setting is forced to OutA if control is equipped with single output or if second output is programmed as alarm.
Outb Set Point 1 is routed through Output B, Set Point 2 (if equipped) is routed through Output A.

S1St Set Point 1 State: Select **dir** or **rE**.
dir Direct Action. As the input increases the output will increase. Most commonly used in cooling processes.
rE Reverse Action. As the input increases the output will decrease. Most commonly used in heating processes.

If **Out1** is set for **##tP**, **#PUL**, or **ProP**, then **S1OL** and **S1OH** (following) appear. If **Out1** is set for **ONOF**, then skip to **S1rE**.

S1OL Set Point Output Low Limit: Select **0** to **100%** but not greater than **S1OH**. This item limits the lowest output value. This is useful for adding a bias to the process when needed. Factory set to **0** for output codes 1,2, and 3. Factory set to **20** for output code 5 (20% output equals 4 mA output).

S1OH Set Point 1 Output High Limit: Select **0** to **100%** but not less than **S1OL** for output codes 1, 2, or 3. Select **0** to **102%** but not less than **S1OL** for output code 5. This item allows setting the maximum output limit. This is useful with processes that are over powered. Adjustment to 102% allows setting current output to force a full on condition for output devices which do not have bias adjustments. Factory set to **100** for all output codes.

If **Out1** is set for **##tP**, **#PUL**, or **ProP**, then skip to **S1LP** on next page.

S1rE Set Point 1 Reset. Select **OnOF** or **Hold**.
OnOF Control will automatically reset when process passes back through **SP1d**.
HoLd Manual Reset. Reset (acknowledge) by simultaneously pressing the **INDEX** & **DOWN ARROW** keys for 5 seconds.

S1Pi Set Point 1 Power Interrupt. Select **On** or **OFF**.
On Alarm Power Interrupt is **On**. Control will automatically reset on power-up if no alarm condition exists.
OFF Alarm Power Interrupt is **OFF**. Control will power-up in alarm condition regardless of condition of process.

- S1iH** Set Point 1 Inhibit: Select **On** or **OFF**.
On Alarm Inhibit is **On**. Alarm action is suspended until the process value first enters a non-alarm condition.
OFF Alarm Inhibit is **OFF**.
- S1LP** Set Point Lamp: Select **O on** or **OoFF**.
O on Lamp ON when Output is ON.
OoFF Lamp OFF when Output is ON.

If your control is not equipped with a second output or if the second output is programmed as an alarm, then proceed to the alarm section (next page).

- S2t** Set Point 2 type: Select **Abs** or **dE**.
AbS Absolute **SP2**. **SP2** is independent of **SP1**, and may be set anywhere between the limits of **SPL** and **SPH**.
dE Deviation **SP2**. **SP2** is set as a deviation from **SP1**, and allows **SP2** to retain its relationship with **SP1** when **SP1** is changed (tracking **SP2**).
- S2St** Set Point 2 State: Select **dir** or **rE**.
dir Direct Action. As the input increases the output will increase. Most commonly used in cooling processes.
rE Reverse Action. As the input increases the output will decrease. Most commonly used in heating processes.

If **Out2** is set for **##tP**, **#PUL**, or **ProP**, then **S2OL** and **S2OH** (following) appear. If **Out2** is set for **ONOF**, then skip to **S2rE**.

- S2OL** Set Point Output Low Limit: Select **0** to **100%** but not greater than **S2OH**. This item limits the lowest output value. This is useful for adding a bias to the process when needed. Factory set to **0** for output codes 1,2, and 3. Factory set to **20** for output code 5 (20% output equals 4 mA output).
- S2OH** Set Point 1 Output High Limit: Select **0** to **100%** but not less than **S2OL** for output codes 1, 2, or 3. Select **0** to **102%** but not less than **S2OL** for output code 5. This item allows setting the maximum output limit. This is useful with processes that are over powered. Adjustment to 102% allows setting current output to force a full on condition for output devices which do not have bias adjustments. Factory set to **100** for all output codes.

- S2rE** Set Point 2 Reset. Select **On** or **Hold**.
- On** Control will automatically reset when process passes back through **SP2d**.
- HoLd** Manual Reset. Reset (acknowledge) by simultaneously pressing the **INDEX & DOWN ARROW** keys for 5 seconds.
- S2Pi** Set Point 2 Power Interrupt. Select **On** or **OFF**.
- On** Alarm Power Interrupt is **On**. Control will automatically reset on power-up if no alarm condition exists.
- OFF** Alarm Power Interrupt is **OFF**. Control will power-up in alarm condition regardless of condition of process.
- S2iH** Set Point 2 Inhibit: Select **On** or **OFF**.
- On** Alarm Inhibit is **On**. Alarm action is suspended until the process value first enters a non-alarm condition.
- OFF** Alarm Inhibit is **OFF**.
- S2LP** Set Point 2 Lamp: Select **O on** or **OoFF**.
- O on** Lamp ON when Output is ON.
- OoFF** Lamp OFF when Output is ON.

The following menu item applies only to the alarm when programmed.

- AL** Alarm function: Select **OFF**, **Lo**, **Hi**, **HiLo**, or **Evnt**.
- OFF** Alarm is disabled. No Alarm menu items appear in the Secondary or Secure menus.
- Lo** Low Alarm Only. **ALLo** appears in the Secondary Menu.
- Hi** High Alarm Only. **ALHi** appears in the Secondary Menu.
- HiLo** High and Low Alarms. Both **ALLo** and **ALHi** appear in the Secondary Menu, and share the same Alarm Relay output.
- Evnt** Alarm is controlled by the Ramp/Soak program function. See pages 11-13 (**#AL**) for further information.

If **AL** is set to **OFF** and the control is not equipped with options, the Secure Menu ends. If **AL** is set to **OFF** or the second output is programmed as control, and the control is equipped with options, proceed to **SPSA**, **Addr**, or **rSCL** on the next page.

If **AL** is set to **Evnt**, go to **ALSt** on the next page.

- ALt** Alarm Type: Select **AbS** or **dE**
AbS Absolute Alarm that may be set anywhere within the values of **SCAL** and **SCAH** and is independent of **SP1**.
dE Deviation Alarm that may be set as an offset from **SP1**. As **SP1** is changed the Alarm Point will track with **SP1**. A deviation alarm will also track any active ramp or soak set point.
- ALRE** Alarm Reset: Select **OnOF** or **Hold**.
OnOF Automatic Reset.
Hold Manual Reset. Reset (acknowledge) by simultaneously pressing the **INDEX & DOWN ARROW** keys for 5 seconds.
- ALPi** Alarm Power Interrupt: Select **On** or **OFF**.
On Alarm Power Interrupt is **On**.
OFF Alarm Power Interrupt is **OFF**.
- ALiH** Alarm Inhibit: Select **On** or **OFF**.
On Alarm Inhibit is **On**. Alarm action is suspended until the process value first enters a non-alarm condition.
OFF Alarm Inhibit is **OFF**.
- ALSt** Alarm Output State: Select **CLOS** or **OPEn**.
CLOS Closes Contacts at Alarm Set Point.
OPEn Opens Contacts at Alarm Set Point.
- ALLP** Alarm Lamp: Select **O on** or **OoFF**.
O on Alarm Lamp is ON when alarm contact is closed.
OoFF Alarm Lamp is OFF when alarm contact is closed.
- ALLb** Alarm Loop Break. Select **On** or **OFF**.
On Loop Break Condition will cause an Alarm Condition.
OFF Loop Break will not affect the Alarm Condition.
- SPSA** *(Option 948, 2-Stage Set Point) Switch Action: Select rE or Int.*
rE *Set Point Stage selected by external contact closures.*
Int *Set Point Stage selected by internal menu selection. See **SP** menu item in Secondary Menu.*
- Addr** *(Option 992, Serial Communications) Control Address: Set from 1 to 3FF. This number (hexadecimal, base 16) must match the address number used by the host computer.*

- bAUd** (Option 992, Serial Communications) Communication Baud Rate: Select **300, 1200, 2400, 4800, 9600, or 19200**. This number must match the baud rate used by the host computer.
- nAt** (Option 992, Serial Communications) No Activity Timer: Set from **OFF** or **1** to **99** minutes.
1 - 99 Maximum time between host computer accesses. If timer counts to 0, CHEC/LorE will be displayed.
OFF No Activity Timer function is disabled.
- rSCL** (Option 924, 926, 928, Analog Remote Set Point) Remote Scale Low: Select **100** to **9999** counts below **rSCH**. The total span between **rSCL** and **rSCH** must be within 11998 counts. Maximum setting range is -1999 to +9999 counts.
- rSCH** (Option 924, 926, 928, Analog Remote Set Point) Remote Scale High: Select **100** to **9999** counts above **rSCL**. The total span between **rSCL** and **rSCH** must be within 11998 counts. Maximum setting range is -1999 to +9999 counts.

SPECIFICATIONS

Selectable Inputs: Thermocouple, RTD, DC Voltage, or DC Current selectable.

Input Impedance:

Thermocouple = 3 megohms minimum.	RTD current = 200 μ A.
Current = 10 ohms.	Voltage = 5000 ohms.

Sensor Break Protection: De-energizes control output to protect system after customer set time. (See **InPt** in Secondary Menu.)

Set Point Range: Selectable (See Range Chart Page 39).

Display: Two 4 digit, 7 segment 6.35 mm (0.25") high LEDs.

Control Action: Reverse (usually heating), Direct (usually cooling) selectable.

Proportional Band: 1 to 9999 °F, °C, or counts.

Reset Time (Integral): Off or 0.1 to 99.9 minutes.

Rate Time (Derivative): Off or 0.01 to 99.99 minutes.

Cycle Rate: 1 to 80 seconds.

On - Off Differential: Adjustable 1° F, 1° C, or 1 count to full scale in 1° F, 1° C, or 1 count steps.

Alarm On - Off Differential: 1° F, 1° C, or 1 count.

Fuzzy Percent: 0 to 100%.

Fuzzy Rate: Off or 0.01 to 99.99 minutes.

Fuzzy Band: Off or 1 to 4000 °F, °C, or counts.

Accuracy: $\pm 0.25\%$ of span, ± 1 least significant digit.

Resolution: 1 degree or 0.1 degree, selectable.

Line Voltage Stability: $\pm 0.05\%$ over the supply voltage range.

Temperature Stability: $4\mu\text{V}/^\circ\text{C}$ ($2.3\mu\text{V}/^\circ\text{F}$) typical, $8\mu\text{V}/^\circ\text{C}$ ($4.5\mu\text{V}/^\circ\text{F}$) maximum (100 ppm / °C typical, 200 ppm / °C maximum).

Common Mode Rejection: 140 db minimum at 60 Hz.

Normal Mode Rejection: 65 db typical, 60 db at 60 Hz.

Isolation:

Relay and SSR outputs: 1500 Vac to all other inputs and outputs.

SP1 Current output: Non-isolated, share common ground with input.

SP1 and SP2 Switched Voltage outputs: Non-isolated, shares common ground with input.

Process Output (934, 936): 500 VAC to all other inputs and outputs.

Supply Voltage: 100 to 240 Vac, nominal., $+10$ - 15% , 50 to 400 Hz. single phase; 132 to 240 Vdc, nominal., $+10$ - 20% .

Supply Voltage (Option 9502): 12 to 24 Vdc, Vac 40-400 Hz, $\pm 20\%$.

Power Consumption: 5VA maximum.

Operating Temperature: -10 to $+55$ °C ($+14$ to 131 °F).

Storage Temperature: -40 to $+80$ °C (-40 to 176 °F).

Humidity Conditions: 0 to 90% up to 40 °C non-condensing, 10 to 50% at 55 °C non-condensing.

Memory Backup: Nonvolatile memory. No batteries required.

Control Output Ratings:

AC SSR (Output A, Output B): 0.75 A @ 240 Vac at 25 °C (77°F). Derates to 0.5 A @ 55° C (130°F).

DC SSR (Output A, Output B): 1.25 A @ 32VDC at 25° C (77°F), derates to 1.0 A at 55° C (130°F).

Relay (Output A, Output B): SPST, 3 A @ 240 Vac resistive; 1.5A @240 Vac inductive; 1/10 HP @ 120 Vac.

Current (non-isolated, Output A only): 0 to 20 mA across 600 ohms maximum.

Switched Voltage (non-isolated, Output A, Output B): 5 Vdc @ 20 mA.

Panel Cutout: 45.0 mm x 22.2 mm (1.772" x 0.874").

Depth Behind Mounting Surface: 111.6 mm (4.395").

Weight: 114 g (4 oz).

Agency Approvals: CE.

Front Panel Rating: Type 4, IP66.

DIAGNOSTIC ERROR MESSAGES

DISPLAY	MEANING	SP OUTPUTS	ACTION REQUIRED
UFL or OFL	Underflow or Overflow: Process value has exceeded input range ends.	Set point outputs active Alarm active	Input signals may normally go above or below range ends. If not, check input and correct.
	UFL or OFL will sequence to display one of these messages if the InPt is set for a time value.	Set point outputs inactive Alarm active	To reset use the INDEX & ENTER keys. When InPt (input fault timer) has been set for a time, the outputs will be turned off after the set time. Setting the time to OFF causes the outputs to remain active, however UFL or OFL will still be displayed.
bAd InP	For RTD inputs RTD is open or shorted.		Correct or replace sensor. To reset use the INDEX & ENTER keys.
OPEn InP	For THERMOCOUPLE inputs thermocouple is open.		
LOOP bAd	The sensor may be defective, heater fuse open, heater open, or the final power output device is bad.	Set point outputs inactive. Alarm active.	Correct or replace sensor, or any element in the control loop that may have failed. Correct the problem, and reset the control by pressing the INDEX and ENTER keys, or index to LPbr and press ENTER .
SEnC bAd	Sensor Rate of Change exceeded the programmed limits set for SEnC .	Set point outputs inactive. Alarm Active	Check for the cause of the error. The value setting may be too slow for the process, or the sensor is intermittent. Correct the problem and press INDEX and ENTER to reset.
CHEC CAL	Check calibration appears as an alternating message if the instrument calibration nears tolerance edges.	Set point outputs active Alarm active	Remove the instrument for service and / or recalibration. To reset use the INDEX & ENTER keys.
	Check calibration appears as a flashing message if the instrument calibration exceeds specification.	Set point outputs inactive Alarm active	Remove the instrument for service and / or recalibration. To reset use the INDEX & ENTER keys.

DIAGNOSTIC ERROR MESSAGES

DISPLAY	MEANING	SP OUTPUTS	ACTION REQUIRED
No display lighted	Display is blank. Instrument is not getting power, or the supply voltage is too low.	Set point outputs inactive Alarm inactive	Check that the power supply is on, or that the external fuses are good.
FAIL tEst	Fail test appears upon power up if the internal diagnostics detect a failure. This message may occur during operation if a failure is detected. Displays flash.	Set point outputs inactive Alarm inactive	The display alternate between FAIL tEst and one of the following messages: FACT dFLt : Memory may be corrupted. Press the ENTER key and the DOWN ARROW key to start the factory default procedure. Recheck controller programming. rEt FACT : Unrecoverable error, return to factory for service.
CHEC SP1, CHEC SP2, CHEC 1SP, ..., CHEC 16SP,	This message will appear upon power up if SP1, SP2, #SP1, or ##SP is set outside of the SPL or SPH values.	Set point outputs inactive Alarm active	Correct the SP1, etc. or adjust the SPL or SPH values by programming new values.
CHEC SPL or CHEC SPH	This message appears at power up if SPL or SPH values are programmed outside the input range ends.	Set point outputs inactive Alarm inactive	Correct the SPL or SPH values by programming new values.
CHEC rSpt	This message appears if the analog remote set point signal is out of range.	Set point outputs active Alarm inactive	The control will revert to SP1. Correction of the analog signal allows the control to return to the remote
CHEC LorE	This message appears if the Serial Communications has timed out.	Set point outputs active Alarm inactive	Restore the communications line and switch the LorE to LOC.
ArEA (Alternates with PV when near)	This message appears if the ambient temperature of the control is near or out of range or RJC sensor is broken.	Set point outputs active Alarms active	Correct the ambient temperature conditions. Ventilate the area of the cabinet or check for clogged filters. If RJC broken, return to factory for service.

Input Ranges (Field Selectable)

Thermocouple Types

Input Type	Type J or L*	Type K*	Type T*	Type E*
Range 1°F 1°C	-100 to +1600 -73 to +871	-200 to +2500 -129 to +1371	-350 to +750 -212 to +398	-100 to +1800 -73 to +982
Input Type	Type R	Type S	Type B	Type C
Range 1°F 1°C	0 to 3200 -17 to +1760	0 to 3200 -17 to +1760	+75 to 3308 +24 to 1820	0 to 4208 -17 to 2320
Input Type	Type N*	* These Input Types can be set for 0.1° display. If temperature goes above 999.9° or less than -199.9° the display will return to whole degree resolution.		
Range 1°F 1°C	-100 to +2372 -73 to +1300			

RTD Types

Input Type	100 Ohm Platinum 0.00385 DIN Curve*	100 Ohm Platinum 0.00392 Nist Curve*	120 Ohm Nickel 0.00628 US Ind. Curve*	1000 Ohm Platinum 0.00385 Nist Curve*
Range 1°F 1°C	-328 to +1607 -200 to +875	-328 to +1607 -200 to +875	-112 to +608 -80 to +320	-328 to +1607 -200 to +875

Process Input Types

The 0 to 20 mAdc, 4 to 20 mAdc, 0 to 10 Vdc, 2 to 10 Vdc, and -10 to +10 mVdc inputs are fully scalable from a minimum of 100 counts span placed anywhere within the within the range of -1999 to +9999. Decimal point position is adjustable from the zero place (9999), tenths (999.9), hundredths (99.99), or thousandths (9.999).

DIMENSIONS

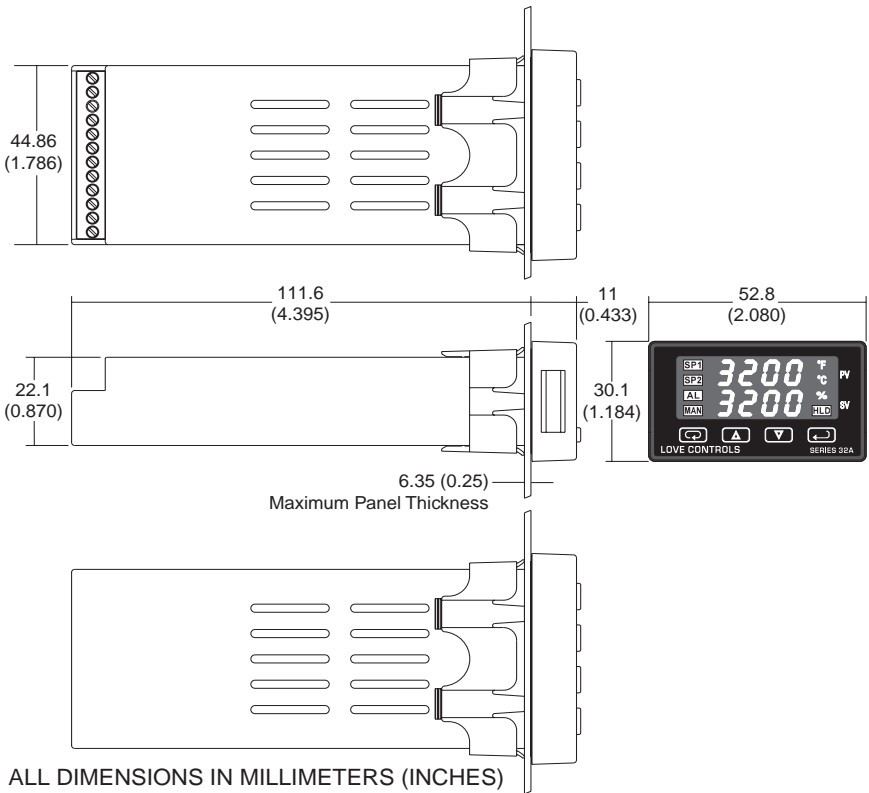

PANEL CUT OUT: $45 +0.6 \times 22.2 +0.3$ ($1.772 +0.02 \times 0.874 +0.012$)

LOVE CONTROLS DIVISION



Dwyer Instruments, Incorporated
 PO Box 338 ○ Michigan City, IN 46361-0338
 (800) 828-4588 ○ (219) 879-8000 ○ FAX (219) 872-9057
www.love-controls.com