

# 1601

## Temperature Controller



Issue date  
March 2000

 **USER'S MANUAL**

0037 - 75236

# CONTENTS

OUTLINE AND CUT OUT DIMENSIONS .....	III
MOUNTING REQUIREMENTS .....	1
CONNECTION DIAGRAMS .....	2
GENERAL OPERATION .....	5
CONFIGURATION HARDWARE SETTINGS .....	5
CONFIGURATION PARAMETERS .....	6
OPERATOR MODE .....	10
Indicators .....	10
Pushbutton function .....	11
Manual reset of the alarms .....	11
SMART algorithm .....	11
Output power OFF .....	12
Direct access to the set point .....	12
Display of the set point value .....	12
Bargraph operating .....	13
Lamp test .....	13
OPERATOR PARAMETERS .....	13
ERROR MESSAGES .....	15
GENERAL INFORMATIONS .....	17
MAINTENANCE .....	18
DEFAULT PARAMETERS .....	A.1

## Model identification

### Model

1601 1/16 DIN Temperature Controller, Single Display

#### Code Output 1 - Heat or Cool

1 Relay, 3 Amps at 250 Vac (Resistive)

6 SSR Drive, 14 Vdc at 20 mA

#### Code Output 2 - Alarm

1 Relay, 1 Amp at 250 Vac (Resistive load)

#### Code

0 Add to complete model number

#### Code Instrument Power

3 100 - 240 Vac

5 24 Vac/dc

#### Code

0 Add to complete model number

1601 6 1 0 3 0 Typical Model Number

# OUTLINE AND CUT OUT DIMENSIONS

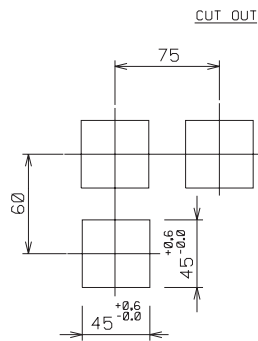
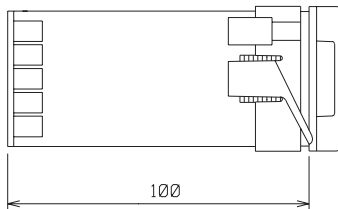
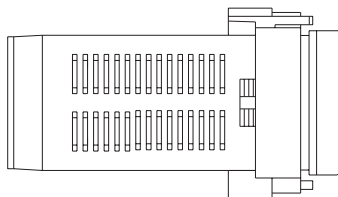
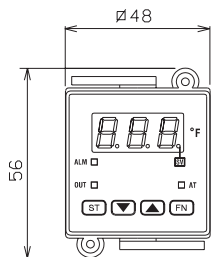



## MOUNTING REQUIREMENTS

Select a mounting location where there is minimum vibration and the ambient temperature range between 0 and 50 °C (32 and 122 °F). The instrument can be mounted on a panel up to 15 mm thick with a square cutout of 45 x 45 mm. For outline and cutout dimensions refer to page IV. The surface texture of the panel must be better than 6.3 μm.

The instrument is shipped with rubber panel gasket.

To assure the IP65 and NEMA 4 protection, insert the panel gasket between the instrument and the panel as show in fig. 1.

While holding the instrument against the panel proceed as follows:

- 1) insert the gasket in the instrument case;
- 2) insert the instrument in the panel cutout;
- 3) pushing the instrument against the panel, insert the mounting bracket;
- 4) with a screwdriver, turn the screws with a torque between 2.7 to 3.5 in-lb (0.3 and 0.4 Nm).

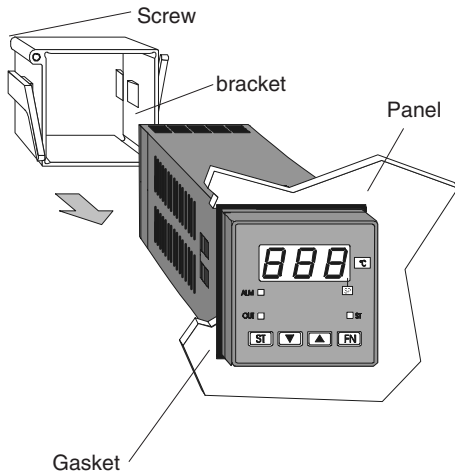

Fig. 1

## CONNECTION DIAGRAMS

Connections are to be made with the instrument housing installed in its proper location.

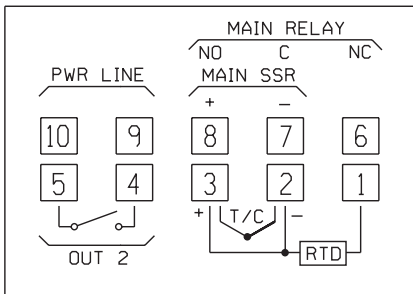

Fig. 2 REAR TERMINAL BLOCK

## A) MEASURING INPUTS

**NOTE:** Any external components (like zener barriers etc.) connected between sensor and input terminals may cause errors in measurement due to excessive and/or not balanced line resistance or possible leakage currents.

## TC INPUT

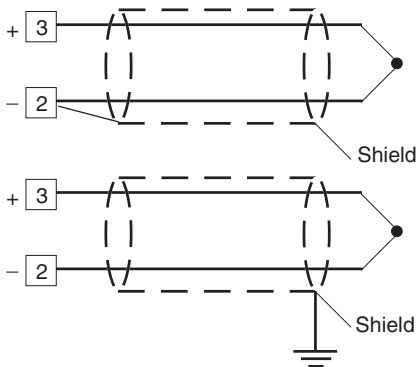

Fig. 4 THERMOCOUPLE INPUT WIRING

## **NOTE:**

- 1) Don't run input wires together with power cables.
- 2) For TC wiring use proper compensating cable (for example, J TC extension wire for J TC) preferable shielded.
- 3) when a shielded cable is used, it should be connected at one point only.

## RTD INPUT

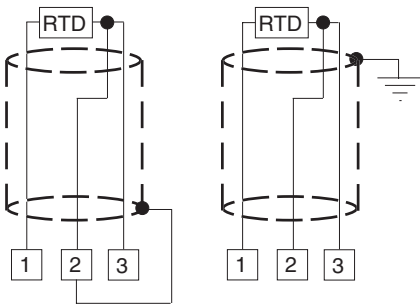

Fig. 5 RTD INPUT WIRING

### NOTE:

- 1) Don't run input wires together with power cables.
- 2) Pay attention to the line resistance; a high line resistance may cause measurement errors.
- 3) When shielded cable is used, it should be grounded at one side only to avoid ground loop currents.
- 4) The resistance of the 3 wires must be the same. Use the same gauge wire for all three conductors.

## B) RELAY OUTPUTS

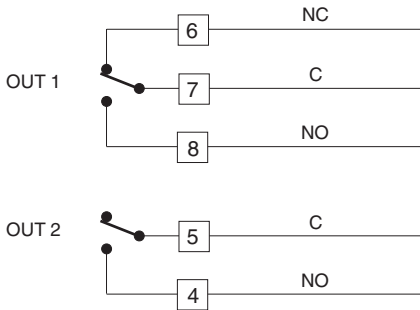

Fig. 6 RELAY OUTPUT WIRING

The OUT 1 NO contact and the OUT 2 contact are protected by varistor against inductive load with inductive component up to 0.5 A.

The contact rating of the OUT 1 is 3A/250V AC on resistive load.

The contact rating of the OUT 2 is 1A/250V AC on resistive load.

The number of operations is  $1 \times 10^5$  at specified rating.

- NOTES**
- 1) To avoid electric shock, connect power line at the end of the wiring procedure.
  - 2) For power connections use No 16 AWG or larger wires rated for at least 75 °C (167°F).
  - 3) Use copper conductors only.
  - 4) Don't run input wires together with power cables.

The following recommendations avoid serious problems which may occur, when using relay output for driving inductive loads.



## INDUCTIVE LOADS

High voltage transients may occur when switching inductive loads.

Through the internal contacts these transients may introduce disturbances which can affect the performance of the instrument.

The internal protection (varistor) assures a correct protection up to 0.5 A of inductive component but the OUT 1 NC contact is not protected.

The same problem may occur when a switch is used in series with the internal contacts as shown in Fig. 7.

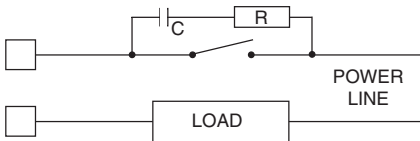

Fig. 7 EXTERNAL SWITCH IN SERIES WITH THE INTERNAL CONTACT

In this cases it is recommended to install an additional RC network across the external contact as show in Fig. 7 (Chromalox snubber PN 0149-01305 is recommended).

The value of capacitor (C) and resistor (R) are shown in the following table.

LOAD (mA)	C ( $\mu$ F)	R ( $\Omega$ )	P. (W)	OPERATING VOLTAGE
<40 mA	0.047	100	1/2	260 V AC
<150 mA	0.1	22	2	260 V AC
<0.5 A	0.33	47	2	260 V AC

Anyway the cable involved in relay output wiring must be as far away as possible from input or communication cables.

## VOLTAGE OUTPUTS FOR SSR DRIVE

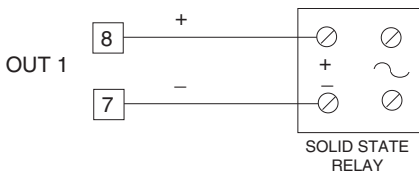

Fig. 8 SSR DRIVE OUTPUT WIRING

It is a time proportioning output.

**Logic level 0:**  $V_{out} < 0.5$  V DC.

**Logic level 1:**

- 14 V  $\pm$  20 % @ 20 mA

- 24 V  $\pm$  20 % @ 1 mA.

Maximum current = 20 mA.

**NOTE:** This output is not isolated.

A double or reinforced isolation between instrument output and power supply must be provided by the external solid state relay.

## A) POWER LINE WIRING

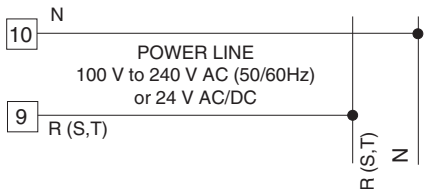

Fig. 3 POWER LINE WIRING

### NOTE:

- 1) Before connecting the instrument to the power line, make sure that line voltage corresponds to the description on the identification label.
- 2) To avoid electric shock, connect power line at the end of the wiring procedure.
- 3) For supply connections use No 16 AWG or larger wires rated for at least 75 °C (167°F).
- 4) Use copper conductors only.
- 5) Don't run input wires together with power cables.
- 6) For 24 V AC/DC the polarity is not important.
- 7) The power supply input has NO fuse protection. Please, provide externally a T type 1A, 250 V fuse.
- 8) The safety requirements for Permanently Connected Equipment are:
  - a switch or circuit-breaker shall be included in the building installation;
  - It shall be in close proximity to the equipment and within easy reach of the operator;
  - it shall be marked as the disconnecting device for the equipment.

**NOTE:** a single switch or circuit-breaker can drive more than one instrument.

## GENERAL OPERATION

There are two setup modes for the 1601

- Configuration mode
- Operator mode

In general the configuration mode is the initial setup of the controller when first installed. Input type and alarm setup are examples of Configuration mode setting. The operator mode includes settings that might be adjusted frequently with daily control operations such as set points and PID parameters.

## CONFIGURATION MODE

### PRELIMINARY HARDWARE SETTINGS FOR CONFIGURATION

- 1) Remove the instrument from its case.

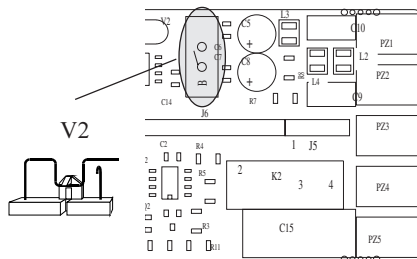

- 2) Set the internal switch V2 in open condition

3) If, during configuration procedure, a °C range has been selected, it is necessary to put the °C label on the front of the instrument covering the °F indication. The sticker is located with the gasket in the shipping box.

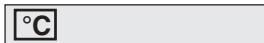

- 4) Re-insert the instrument.  
 6) Power the instrument "ON".  
 The display will show CnF.  
**NOTE** : If "CAL" indication is displayed, press immediately the ▲ pushbutton to return to the configuration procedure.  
 7) Push the FUNC pushbutton.  
 The parameter code and its value are shown alternately on the display.

### Pushbutton functionality during configuration procedure.

- FUNC** = Must be pressed to store the new value of a selected parameter and increments to the next parameter.
- SMART**= in configuration mode, scrolls parameters back (in reverse order) without storing the new parameter value.
- ▲ = increases the value of the selected parameter
- ▼ = decreases the value of the selected parameter.

## CONFIGURATION PARAMETERS

### P1 - Input type and standard range

0	= TC type	L	range	0 / +800 °C
1	= TC type	J	range	0 / +800 °C
2	= TC type	K	range	0 / +999 °C
3	= TC type	N	range	0 / +999 °C
4	= RTD type	Pt 100	range	-199 / +500 °C
5	= RTD type	Pt 100	range	-19.9 / +99.9 °C
6	= TC type	T	range	0 / +400 °C
8	= TC type	L	range	0 / +999 °F
9	= TC type	J	range	0 / +999 °F
10	= TC type	K	range	0 / +999 °F
11	= TC type	N	range	0 / +999 °F
12	= RTD type	Pt 100	range	-199 / +999 °F
13	= TC type	T	range	0 / +752 °F

**NOTE**: setting a readout with °F as engineering unit it is necessary to put on the front of the instrument, the additional label located in the "INDEX" of this manual.

### P2 = Initial scale value

Not present when P1 = 5  
 Insert the initial and full scale values which are going to be used by the PID algorithm to calculate the input span.

### P3 = Full scale value

Not present when P1 = 5  
 Insert the initial and full scale values which are going to be used by the PID algorithm to calculate the input span.

#### NOTES:

- 1) the minimum input span (P3 - P2) is 300 °C or 600 °F for TC input and 100 °C or 200 °F for RTD input.
- 2) Changing P2 and/or P3 parameters, the rL and rH parameters will be realigned to it.

#### P4 = Main output action

r = reverse action (heating)

d = direct action (cooling)

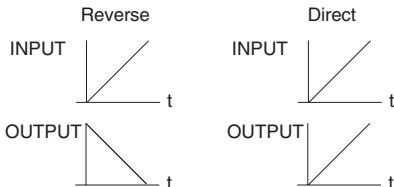

#### P5 = Output 2 functions

0 = Not provided

1 = Process alarm

2 = Band alarm

3 = Deviation alarm

4 = instrument failure indicator (under or over range, CJC, or A-D converter failure)

#### P6 = Output 2 operator mode.

P6 is available only when P5 is different from 0.

When P5 = 1,2 or 3

H.A = high alarm (outside band) with automatic reset

L.A = low alarm (inside band) with automatic reset

H.L = high alarm (outside band) with manual reset (latching)

L.L = low alarm (inside band) with manual reset (latching)

When P5 = 4 the selections H.A and L.A show an instrument failure indicator with automatic reset while the H.L and L.L selections show an instrument failure indicator with manual reset.

#### P7 = Alarm action

Available only when P5 is different from 0 or 4.

r = reverse (relay de-energized in alarm condition)

d = direct (relay energized in alarm condition)

#### P8 = Alarm inhibit

Present only when P5 is different from 0 or 4.

OFF = inhibit disabled

ON = inhibit enabled

**NOTE:** If the alarm is programmed as band or deviation alarm, this function disables the alarm condition after a set point change or at the controller startup until the process variable passes the alarm set point plus or minus hysteresis. If the alarm is programmed as process alarm, this function disables the alarm condition at controller start up until the process variable pass the alarm set point plus hysteresis.

#### P9 = OFFSET applied to the measured value

This OFFSET is applied along the whole range.

When P1 = 5 P9 is programmable from -19.9 to 19.9 °C.

When P1 ≠ 5 P9 is programmable from -199 to 199 °C or °F.

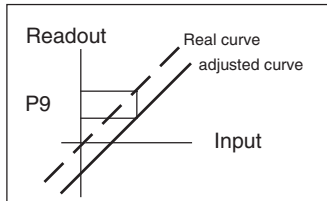

### P10 = Threshold of the "Soft Start" function.

Enter the threshold value, in °C or °F, for the automatic start of the "Soft Start" function (limiting output power). If the unit powers up below the threshold value, the "Soft Start" function is enabled and limits the power output to "OLH" for "tOL" minutes. "OLH" and "tOL" are set in operator mode.

### P11 = User defined security code

- 0 = device unlocked. All the parameters can be modified
- 1 = device locked. None of the parameters can be modified except the SP.
- 2 to 499 = Select the security code. **During the "operator mode"**, the "software key" parameter will show one of the following figures:

A) 

OFF
n n n

The device is "Unlocked" and all parameters can be modified.

To make the device "Locked" insert a number different from the "security code". Now none of the parameters can be modified except the SP.

B) 

ON
n n n

The device is "locked" and none of the parameters can be modified except the SP.

To "Unlock" the device, insert the "security code".

500 to 999 = when selecting a security code between these two numbers, the operation is identical to a selection from "2 to 499" except that both the set point and the alarm set point can be modified.

### P12 = Control output maximum rate of rise

Programmable from 1 % to 10 % of the output per second.

The ramp is applied when the controller changes the percent of output desired. Above a 10 % the display will show "InF" meaning that no ramp is imposed and the output immediately changes to the PID calculated value.

P12 not used if ON/OFF control selected.

### P13 = Not used

## ADVANCED CONFIGURATION

The configuration procedure is completed and the instrument shows " - . - . - . " on both displays. When it is desired to end the configuration procedure push the FUNC pushbutton; the display will show "CnF".

When it is desired to access to the advanced configuration parameter procede as follows:

- 1) using ▲ and ▼ pushbutton set to 219.
- 2) push the FUNC pushbutton.

**P14 -Display of the operator parameters.**

This parameter is available only if P11 is different from 0.

This parameter allows you to enable/disable the display of the protected parameters during "operator mode".

OFF = protected parameters cannot be displayed  
ON = protected parameters can be displayed

**P15 - SMART function enabling/ disabling**

- 0 = The SMART function is disabled
- 1 = The SMART function enabling/disabling is NOT protected by the security code (P11).
- 2 = The SMART function enabling/disabling is protected by the security code (P11).

**P16 - Maximum value of the proportional band settable by the SMART function**

This parameter may be programmed from P17 or P18 value to 99.9.

**P17 - Minimum value of the proportional band settable by the SMART function in heating control only.**

It may be programmed from 1.0% to P16 value.

**P18 - Not Available****P19 - Not Available****P20 - Minimum value of integral time settable by SMART function.**

P20 is programmable from 00.1 (10 seconds) to 02.0 (2 minutes).

**P21 = Extension of the anti-reset-wind up**

Range: from -30 to +30 % of the proportional band.

**NOTE:** a positive value increases the high limit of the anti-reset-wind up (over set point) while a negative value decreases the low limit of the anti-reset-wind up (under set point).

The advanced configuration procedure is completed and the instrument shows " CnF" on the display.

Pressing the "FUNC" will return the unit to the first configuration parameter.

# OPERATOR MODE

## PRELIMINARY

To make the instrument operate as a controller the internal switch V2 located on the input card (see Fig. 9) must be closed.

It is assumed, at this point, that the instrument has been correctly configured as detailed in Section 3. The instrument shows the process value or the set point value (in this case the SP LED will be flashing). In order to toggle the indication push the ▲ pushbutton. (this display condition is defined as “normal display mode”).

Pressing the FUNC pushbutton it is possible to scroll all the operator parameters. Instrument display alternates between parameter code and its value. During modification, only the parameter value will be displayed. To modify a parameter, first select the desired parameter by the FUNC pushbutton, then set the new value by ▲ or ▼ pushbuttons. Press FUNC pushbutton to store the new value and step to the next parameter.

**NOTE:** 1) If, during parameter modification, no pushbutton is pressed for more than 10 seconds, the instrument reverts automatically to the “normal display mode” and the new setting of the last parameter will be lost.

- 2) The instrument doesn't display all the parameters.  
It selects the parameters in accordance with:
  - a) The instrument configuration in general (see chapter 3),
  - b) The P14 parameter in particular (see chapter 3),
  - c) The proportional band value (see page 4.2).

## INDICATORS

- |       |  |
|-------|--|
| SMART | Flashing when the first part of the SMART algorithm is active.<br>Lit when the second part of the SMART algorithm is active. |
| OUT   | Lit when the OUT 1 is in ON condition.   |
| ALM   | Lit when the alarm 1 is in the alarm state.  |
| SP    | Flashing when the display shows the control set point.   |

### Pushbutton functions:

**FUNC** = Stores the new value of the selected parameter and goes to the next parameter.

**SMART** = Enables or disables the SMART function and scrolls back all the parameters without storing them.

**▲** = Increases the value of the selected parameter or toggles the display between the set point value and the measured value.

**▼** = Decreases the value of the selected parameter.

**▼ + FUNC** = Enables/disables the "LAMP TEST"

**NOTE:** a 10 seconds time out becomes operational during parameter modification.

If, during operator parameter modification, no pushbutton is pressed for 10 seconds, the instrument reverts automatically to the "normal display mode". The new setting of the last parameter modified is going to be memorized, prior to the time out, only if the FUNC pushbutton was depressed.

### MANUAL RESET OF THE ALARMS

If the alarm has been configured as a latched alarm, the alarm status persists after the alarm condition disappears.

To reset the alarm, push the FUNC pushbutton and select the "n.rS" parameter (the display will show "n.rS" and "OFF"). Using the **▲** and **▼** pushbuttons select "ON" and push the FUNC pushbutton again.

The alarm cannot be reset until the alarm condition has disappeared.

### SMART ALGORITHM

The SMART feature automatically sets the best control action.

To enable the SMART function, push the SMART pushbutton for more than 1.5 s, when the instrument is in normal display mode. The SMART LED will light continuously or flash according to the algorithm automatically selected.

When the smart function is enabled, it is possible to display but not to modify the control parameters (PB, TI, TD and rC).

When the traditional control (PID) is desired, push the SMART pushbutton again (for more than 1.5 s) to turn the "SMART" OFF. The instrument maintains the "SMART" set of control parameters but allows parameter modification.

#### NOTES:

- 1) The SMART function uses a derivative time equal to 1/4 of the integral time.
- 2) The limits of the proportional band set by the SMART function are programmed by P16, P17 and P18 parameters.
- 3) The lower limit of the integral time set by SMART function is programmed by P20 parameter.
- 4) When ON/OFF control is programmed (PB=0), the SMART function is disabled.
- 5) The SMART enabling/disabling can be protected by the security code (see P15 parameter).



## OUTPUT POWER OFF

The Output Power OFF feature turns off the control and alarm output allowing modification of parameters without affecting the process. With the output off the 1601 can be used as an indicator.

To turn OFF the output signal, hold the ▲ pushbutton first and then push FUNC pushbutton.

After maintaining pressure on both of them for more than 3 seconds, the instrument will show "OFF" instead of the set point value.

Since the 1601 has only one display, it is possible to toggle from "OFF" to measured value by depressing the ▲ pushbutton.

In the output power off condition the alarms are in no alarm condition (the alarm output status depends on the type of alarm action programmed) and the parameters can be reviewed and modified.

When it is desired to come back to normal control, Hold the ▲ pushbutton first and then push the FUNC pushbutton.

Maintaining pressure on both of them for more than 3 seconds, the instrument will return in NORMAL DISPLAY MODE.

### NOTES :

- 1) If the output is turned OFF when the SMART function was performing the first part of the algorithm (LED SMART is flashing), the SMART function will be aborted and when the instrument comes back to the normal control, the SMART function will be disabled.  
If the output is turned OFF when the SMART function was performing the second part of the algorithm (LED SMART is lit), the SMART function will be stopped and, when the instrument comes back to the normal control, the smart function also will be activated.
- 2) If the instrument is turned OFF with the output power off function enabled, at the next start up

the instrument will automatically enable this function again.

## DIRECT ACCESS TO THE SET POINT MODIFICATION

This feature allows the set point value to be modified without using the FUNC pushbutton. When direct access to set point modification is required, proceed as follows:

- 1) Push, for more than 3 seconds, the ▲ or ▼ pushbutton; the set point value, will be displayed and it will start to change.
- 2) Using the ▲ and ▼ pushbuttons, it is possible to set the desired value.
- 3) When the desired value is reached, do not push any pushbutton for more than 3 second, the new set point will become operative after 3 seconds.

If, during this procedure, there is no interest in saving the new value, push the FUNC pushbutton; the instrument will automatically return to the normal display mode without having saved the new set point.

## DISPLAY OF THE SET POINT VALUE

To display the programmed set point value push the ▲ pushbutton.

The display will show the set point value and the decimal point of the last significant digit will flash to indicate that the number shown is the set point value.

To come back to display the measured value, push the ▲ pushbutton again.

## LAMP TEST

To verify operation of the display LED, push ▼ and FUNC together. The instrument LEDs will flash until the Lamp Test is turned off.

To turn off the Lamp Test, press ▼ and FUNC together.

No other pushbutton functions are operable during the Lamp Test.

## OPERATOR PARAMETERS

The following is a list of all the available control parameters. Note that some parameters may not be displayed according to the specific instrument configuration.

Push the FUNC pushbutton, the 1601 will alternately show the parameter and its value or the status (ON or OFF) of the selected parameter.

Using ▲ or ▼ pushbutton it is possible to set the desired value or the desired status.

By pushing the FUNC pushbutton, the instrument saves the new value (or the new status) and goes to the next parameter.

Param.	DESCRIPTION
SP	Set point (in eng. units). Range: from rL to rH.
n.rS	Manual reset of the alarms. This parameter is available only when a latching alarm has been programmed. Set ON and push the FUNC pushbutton to reset the alarms.
nnn	Security code for parameter protection. This parameter is skipped if P11 = 0 or 1 ON = the instrument is in LOCK condition OFF = the instrument is in UNLOCK condition When it is desired to switch from LOCK to UNLOCK condition, set a value equal to P11 parameter. When it is desired to switch from UNLOCK to LOCK condition, set a value different from P11 parameter.
AL	Alarm set point(in eng. units). This parameter is present if an alarm is configured.

	Ranges: - From P2 to P3 for process alarm. - From 0 to 500 units for band alarm. - From -199 to 500 units for deviation alarm.		Range: from 1 s to 9 min. and 59 s; if 0 is set, the derivative action is excluded.
HSA	Alarm hysteresis (in % of P3 - P2 span) This parameter is present if an alarm is configured. Range: From 0.1% to 10.0% of the input span or 1 LSD. <b>Note:</b> If the hysteresis of a band alarm is larger than the alarm band, the instrument will use an hysteresis value equal to the programmed band minus 1 digit.	IP	Integral pre-load This parameter is skipped when PB = 0. Range: - from 0 to 100% for one control output
		C	Output 1 (heating) cycle time (in seconds) This parameter is present if PB parameter is different from 0 only. Range: From 1 to 200 s.
Pb	Proportional band (in % of P3 - P2 span) Range: from 1.0 % to 99.9 % of span for heating output. When PB parameter is set to 0, the instrument performs an ON-OFF control; the ti, td, C, OLH and tOL parameters are skipped and SMART function is disabled.	rL	Set point low limit (in eng. units). Range: from min. range value (P2) to rH. <b>Note:</b> When P2 has been modified, rL will be realigned to it.
		rH	Set point high limit (in eng. units). Range: from rL to full scale value (P3). <b>Note:</b> When P3 has been modified, rH will be realigned to it
HS	Hysteresis for ON/OFF control action (in % of P3 - P2 span) This parameter is available only when Pb=0. Range: from 0.1% to 10.0% of the input span.	OLH	Output high limit (in % of the output). This parameter is present if PB parameter is different from 0 only. Range: from 0.0 to 100.0
ti	Integral time (in minutes and seconds [mm.ss]). This parameter is skipped if Pb=0 (ON/OFF action). Range: from 00.1 to 20.0 [mm.ss]. Above this value the display blanks and integral action is excluded	tOL	Time duration of the output power limiter. The tOL is a programmable time in which the output level is limited to OLH value. This timer starts at instrument power up if the measured variable is less than the threshold value programmed (P10 parameter). This parameter is present if PB parameter is different from 0. Range: from 1 minute to 100 minutes. Above "100", the upper display shows "InF" and the "OLH" limit will always be enabled independently from P10 parameter value.
td	Derivative time (in minutes and seconds [mm.ss]). This parameter is skipped if Pb=0 (ON/OFF action).		<b>Note:</b> The tOL can be modified but the new value will become operative only at

the next instrument start up.  
**ERROR MESSAGES**

**OVERRANGE, UNDERRANGE AND BURN-OUT INDICATIONS**

The instrument shows the OVERRANGE and UNDERRANGE conditions with the following indications:



The sensor leads break can be signalled as:

- for TC input : OVERRANGE or UNDERRANGE If required see Chromalox for set up.
- for RTD input : OVERRANGE

Sensor leads short circuit detection:

On RTD input, a special test is provided to signal OVERRANGE when input resistance is less than 15 ohm (Short circuit sensor detection).

**NOTE:** When:

- The instrument is set for one output only and an OVERRANGE is detected, the OUT 1 turns OFF (if reverse action) or ON (if direct action).
- The instrument is set for one output only and an UNDERRANGE is detected, the OUT 1 turns ON (if reverse action) or OFF (if direct action).

**NOTE:** when an overrange or an underrange is detected, the alarm operates as if a maximum or a minimum measurable value is present.

To eliminate the OUT OF RANGE condition, proceed as follows:

- 1) Check the input signal source and the connecting line.
- 2) Make sure that the input signal is in accordance with instrument configuration. Otherwise, modify the input configuration P1 (see chapter 3.2).
- 3) If no error is detected, send back the instrument to your supplier for a check.

## ERRORS

Diagnostics are run at instrument power up and during normal mode of operation.

If a fault condition (error) is detected the display will alternately show "Er" and the error number. The following is a list of possible errors in numerical order.

Also causes, instrument output conditions and possible remedies are briefly described.

Some errors reset the instrument; if the error persist, send back the instrument to your supplier.

## ERROR LIST

100	Write EEPROM error.
150	General hardware error on the CPU card.
200	Protect register memory error. The controller performs this check every 2 seconds. Set the switch V2 in open condition. Switch on the controller. Set the switch V2 in closed condition and power the controller.
201 - 219	Configuration parameter error (2xx, where xx is the Configuration code).

301  
305  
307  
400

The two less significant digit's show the number of the wrong configuration parameter. Return to the configuration procedure and check the values.

RTD calibration error.  
Thermocouple input calibration error.  
RJ input calibration error  
One or more control parameters are out of range with respect to the allowed values.

It may appear at controller power up after configuration changes.

Push and hold ▼ and ▲ pushbuttons simultaneously and load all the default parameters.

This will not change the configuration parameters.

500  
502  
510

Auto-zero error  
RJ error  
Error during calibration procedure

## CALIBRATION

Fig. 11

Dip switch location: To start calibration, V2 must be OPEN.

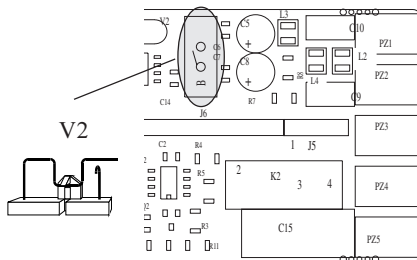

## GENERAL GUIDELINES FOR CALIBRATION

### NOTE:

**All 1601 are calibrated at the manufacturing plan. It is not necessary to calibrate the 1601 on receipt.**

For an good calibration it is necessary to proceed as follows:

- 1) - The controller under calibration should be mounted in its case in order to keep the internal temperature stable.
- 2) - The ambient temperature should be stable. Avoid any drift due to air-conditioning, etc.
- 3) - The relative humidity should not exceed 70%.
- 4) - Minimum warm-up time must be 20 minutes.
- 5) - If possible, operate in a noise free environment
- 6) - During calibration, connect one input at a time to the rear terminal block.

## WARNING:

**Do not attempt calibration without the recommended simulator or calibrator.**

For this calibration procedure it is necessary to use calibrators with the following accuracy and resolution:

### ACCURACY

- 1) For TC input: + 0.005% output + 0.001% range + 5  $\mu$ V
- 2) For RTD input:  $\pm 0.02\%$   $\pm 0.0025\ \Omega/\text{decade}$ .
- 3) For cold junction compensation: better than 0.1  $^{\circ}$ C

### RESOLUTION

- 1) For TC input: 1  $\mu$ V
- 2) For RTD input: 10 m $\Omega$
- 3) For cold junction compensation: better than 0.1  $^{\circ}$ C

## CALIBRATION PROCEDURE

Calibration parameters are logically divided in groups of two parameter each (initial and final scale value). After each group, the calibration check is provided but it is also possible to be the check without calibrating.

### NOTE:

Pushing the SMART pushbutton goes back to the previous parameter without modifying the calibration.

All the controllers are originally calibrated at the factory by means of calibrators with high accuracy and resolution.

The following is a complete list of calibration symbols:

Code	Parameter
tL	TC input initial scale value (0 mV)
tH	TC input full scale value (50 mV)
t	TC input check
rJ	Cold junction compensation
rJ.	Cold junction compensation check
PL	RTD input initial scale value (0 $\Omega$ )
PH	RTD input full scale value (300.00 $\Omega$ )
P.	RTD input check.

### Now to proceed

- 1) to start calibration, V2 must be OPEN (see Fig. 11).
- 2) Switch on the controller. The display will show "CnF".
- 3) Push the  $\blacktriangle$  pushbutton, the display will show "CAL".
- 4) Push the FUNC pushbutton to display the first calibration code.
- 5) Depress FUNC pushbutton in sequence until the desired calibration code is reached.

### RTD Calibration only:

If only calibrating RTDs, press FUNC until the "PL" parameter is displayed and proceed to page 19 (PL) for other instructions.

### "tL" - TC INPUT- INITIAL SCALE VALUE

- 1) Provide connections between calibrator and controller under test as shown in fig. 12.
- 2) The display will show "tL.F" (where "F" means "OFF").
- 2) Set calibrator to 0.000 mV.

- 3) Push  $\blacktriangle$  or  $\blacktriangledown$  pushbutton, the display will change to "tL.n" (where "n" means "On").
- 4) After 30 seconds, start calibration by pushing the FUNC pushbutton.  
Only the decimal point of the last significant digit will light to indicate that the controller is performing the calibration routine.  
At the end of this calibration routine, the controller will go to the next step.

Fig. 12

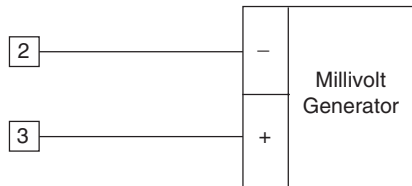

### "tH" - TC INPUT - FULL SCALE VALUE

- 1) After "tL" is calibrated, the 1601 will show "tH.F" for the full scale value.
- 1) Set the calibrator to 50.000 mV (full scale value).
- 2) Push  $\blacktriangle$  or  $\blacktriangledown$  pushbutton, the display will change to "tH.n".
- 3) After 30 seconds, start calibration by pushing FUNC pushbutton. Only the decimal point of the last significant digit will light to indicate that the controller is performing the calibration routine.  
At the end of this calibration routine, the controller will go to the next step.

## "t" - TC INPUT CHECK

- 1) The display will show "t." and the two most significant digits of the measurement alternately with the remaining digits as shown in the following figure:

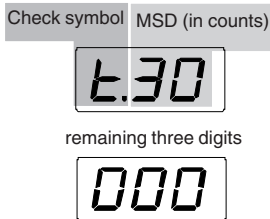

The "tH" calibration is correct if the indication shown is equal to "t.30" and "000"  $\pm$  10 counts.

- 1) Check the zero calibration, by setting the calibrator to 0.000 mV, the read-out must be equal to "t. 0" and "000"  $\pm$  10 counts.
- 2) Check the half scale linearity by setting the calibrator to 25.000 mV. The read-out must be "t.15" and "000"  $\pm$  10 counts.

**NOTE:** when it is desired to use a different check point, the following formula describes the ratio between the signal input and the instrument read-out (in counts).

$$\text{Instrument readout (in counts)} = \frac{\text{input value}}{50 \text{ (mV)}} \cdot 30000$$

- 3) If linearity is incorrect, repeat thermocouple calibration.
- 4) Push FUNC pushbutton, the instrument will go to the next calibration group.

## COLD JUNCTION CALIBRATION

**NOTE:** make sure that "tL" and "tH" parameters are correctly calibrated before "rJ" parameter calibration.

### rJ - ACTUAL VALUE

The display will show "rJ.F" (where "F" means "OFF").

- 1) Measure the temperature close to terminals 2 and 3 using an instrument with accuracy better than 0.1 °C (see Fig. 13).

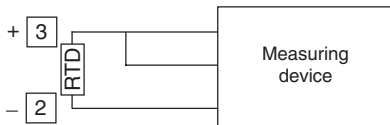

Fig. 13

- 2) Wait for a few minutes to allow the temperature to stabilize over the entire system (sensor, calibrator and instrument).
- 3) Using ▲ or ▼ push-button, set a value equal to the temperature measured by the measuring device in a tenth of °C.
- 4) Start the calibration by pushing the FUNC pushbutton. Only the decimal point of the last significant digit will light to indicate that the controller is performing the calibration routine. At the end of this calibration routine, the controller will go to the next calibration step.



## "rJ" - COLD JUNCTION COMPENSATION CHECK

The "rJ" code and the temperature, in tenths of °C, measured by the CJ compensator are shown alternately on the display.

- 1) Make sure that the cold junction temperature measured by the controller is equal to the value measured by the measuring device.
- 2) Push FUNC pushbutton, the instrument will go to the next calibration parameter.

### TC Calibration only:

Thermocouple calibration is now complete, if RTD calibration is not needed, press FUNC until "CAL" is displayed see step 5 at page 21

## RTD INPUT CALIBRATION

### "PL" - RTD INPUT - INITIAL SCALE VALUE

The display will show "PL.F" (where "F" means "OFF").

- 1) Connect a resistor box as shown in fig. 14.

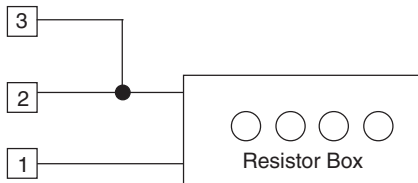

Fig.14

- 2) Set 0.00 Ω on the resistor box.
- 3) Push ▲ or ▼ pushbutton, the display will change to "PL.n" (where "n" means "On").

- 4) After 30 seconds, start the calibration by pushing the FUNC pushbutton. Only the decimal point of the last significant digit will light to indicate that the controller is performing the calibration routine. At the end of this calibration routine, the controller will go to the next parameter.

### "PH" - RTD INPUT - FULL SCALE VALUE

The display will show "PH.F" (where "F" means "OFF").

- 1) Set the resistor box to 300.00 Ω.
- 3) Push ▲ or ▼ pushbutton, the display will change to "PH.n" (where "n" means "On").
- 4) After 30 seconds, start the calibration by pushing the FUNC pushbutton. Only the decimal point of the last significant digit will light to indicate that the controller is performing the calibration routine.

At the end of this calibration routine, the instrument will go to the next step.

### "P." - RTD INPUT CHECK

The "P." code followed by the two most significant digits and the remaining digits of the measured value are shown alternately on the display.

Check symbol

MSD (in counts)

P.30

remaining three digits

000

The "PH" calibration is correct if the indication is "P.30" and "000"  $\pm$  10 counts.

- 1) Check the zero calibration, by setting 0.00  $\Omega$  on the the resistor box.

The result should be "P. 0" and "000"  $\pm$  10 counts.

- 2) Check the linearity by setting 100.00  $\Omega$  on the the resistor box. The result should be "P.10" and "153"  $\pm$  10 counts.

- 3) Set 200.00  $\Omega$  on the the resistor box.

The result should be "P.20" and "151"  $\pm$  10 counts.

- 4) Push the FUNC pushbutton.

The calibration procedure is complete and the display will show "CAL". When it is desired to go to the configuration procedure, depress the  $\blacktriangle$  pushbutton and the display will show "CnF" and the controller is in configuration mode. If the previous configuration is correct, switch the controller OFF and set the switch V2.

## GENERAL INFORMATION

### GENERAL SPECIFICATIONS

**Case:** ABS grey color (RAL 7043); self-extinguishing degree: V-0 according to UL 94.

**Front protection** - designed and tested for IP 65 (\*) and NEMA 4X (\*) for indoor locations (when panel gasket is installed).

(\*) Test were performed in accordance with CEI 70-1 and NEMA 250-1991 STD.

**Installation:** panel mounting by means of mounting bracket. Instrument removable from case.

**Rear terminal block:** 10 screw terminals ( screw M3, for cables from  $\phi$  0.25 to  $\phi$  2.5 mm<sup>2</sup> or from AWG 22 to AWG 14 ) with connection diagrams and safety rear cover.

**Dimensions:** 48 x 48 mm, depth 100 mm (DIN 43700).

**Weight:** 160 g max.

**Power supply:**

- 100V to 240V AC 50/60Hz (-15% to + 10% of the nominal value).

- 24 V AC/DC ( $\pm$  10 % of the nominal value).

**Power consumption:** 6 VA max.

**Insulation voltage:** 2300 V rms according to EN 61010-1.

**Display updating time:** 500 ms.

**Sampling time:** 500 ms.

**Resolution:** 30000 counts.

**Accuracy** (@ 25 °C):  $\pm 0.3\%$  of the input span  $\pm 1$  °C.

**Common mode rejection:** 120 dB at 50/60 Hz.

**Normal mode rejection:** 60 dB at 50/60 Hz.

**Electromagnetic compatibility and safety**

**requirements:** This instrument is marked CE.

Therefore, it is conforming to council directives 89/336/EEC (reference harmonized standard EN-50081-2 and EN-50082-2) and to council directives 73/23/EEC and 93/68/EEC (reference harmonized standard EN 61010-1).

**Installation category:** II

**Temperature drift:** < 200 ppm/°C (RJ excluded)  
<400 ppm/°C for RTD input with -19.9/99.9 °C range and TC type T.

**Reference junction drift:** 0.1 °C/°C.

**Operative temperature:** from 0 to 50 °C (32 to 122°F).

**Storage temperature :** -20 to +70 °C (-4 to 158°F).

**Humidity:** from 20 % to 85% RH, non condensing.

**Protections:**

- 1) WATCH DOG circuit for automatic restart.
- 2) DIP SWITCH for protection against tampering of configuration and calibration parameters.

## INPUTS

### A) THERMOCOUPLE

**Type:** L, J, K, N, T programmable by front pushbuttons.

**Line resistance:** max. 100  $\Omega$  with error  $\leq \pm 0.1\%$  of the input span.

**Engineering unit:** °C or °F programmable.

**Reference junction:** automatic compensation from 0 to +50 °C.

**Reference junction drift :** 0.1 °C/°C.

**Burn-out:** Up or down scale selectable.

**Calibration:** according to IEC 584-1 and DIN 43710 - 1977 (TC L)

### STANDARD RANGES TABLE

TC type	Measuring ranges	
L	0 - +800 °C	0 - +999 °F
J	0 - +800 °C	0 - +999 °F
K	0 - +999 °C	0 - +999 °F
N	0 - +999 °C	0 - +999 °F
T	0 - + 400 °C	0 - +752 °F

## B) RTD (Resistance Temperature Detector)

**Type:** Pt 100 3 wires connection.

**Current:** 135  $\mu$ A.

**Line resistance:** automatic compensation up to 20  $\Omega$ /wire with :

- error  $\pm 0.1\%$  of the input span for range -19.9 a 99.9  $^{\circ}$ C.

- not measurable error for the other ranges.

**Engineering units:**  $^{\circ}$ C or  $^{\circ}$ F programmable.

**Burn-out:** up scale. **NOTE:** a special test is provided to signal OVERRANGE when input resistance is less than 15  $\Omega$ .

**Calibration:** according to DIN 43760

### STANDARD RANGES TABLE

RTD TYPE	Measuring range	
RTD Pt 100	-199 - +500 $^{\circ}$ C	-199 - +999 $^{\circ}$ F
RTD Pt 100	-19.9 - +99.9 $^{\circ}$ C	-----

## CONTROL ACTIONS

**Control actions:** PID + SMART

**Proportional band:** from 1.0 % (for heating action) or 1.5 % (for heating and cooling action) to 99.9 % of the input span.

Setting Pb = 0 an ON/OFF control is performed.

**Hysteresis** (for ON/OFF control action): from 0.1 % to 10.0 % of the input span.

**Integral time:** from 10 seconds to 20 minutes; resolution 10 second. Setting a value upper than 20 minutes the integral action will be excluded.

**Derivative time:** from 0 to 9 minutes and 59 seconds.

**Integral preload:**

- from 0 to 100% for one control output.

**Heating cycle time:** from 1 to 200 s.

**NOTE:** the PB, TI and TD parameters may be limited when the SMART function is enabled.

## CONTROL OUTPUTS

### OUTPUT 1 - heating:

- Relay output with SPDT contact; contact rating 3A / 250 V ac on resistive load.
- Logic voltage for SSR drive.  
Logic status 1: 24 V  $\pm 20\%$  @ 1 mA.  
14 V  $\pm 20\%$  @ 20 mA  
Logic status 0:  $< 0.5$  V

**Output action:** direct/reverse programmable

### OUTPUT 2 - alarm 1:

- Relay output with SPST contact; contact rating 1A / 250 V ac on resistive load. By internal jumper it is possible to select the NC or NO contact.

## MAINTENANCE

- REMOVE POWER FROM THE POWER SUPPLY TERMINALS AND FROM RELAY OUTPUT TERMINALS
- Remove the instrument from case.
- Using a vacuum cleaner or a compressed air jet (max. 3 kg/cm<sup>2</sup>) remove all deposit of dust and dirt which may be present on the louvers and on the internal circuits trying to be careful for not damage the electronic components.
- To clean external plastic or rubber parts use only a cloth moistened with:
  - Ethyl Alcohol (pure or denatured) [C<sub>2</sub>H<sub>5</sub>OH] or
  - Isopropil Alcohol (pure or denatured) [(CH<sub>3</sub>)<sub>2</sub>CHOH] or
  - Water (H<sub>2</sub>O)
- Verify that there are no loose terminals.
- Before re-inserting the instrument in its case, be sure that it is perfectly dry.
- re-insert the instrument and turn it ON.

## DEFAULT PARAMETERS

### DEFAULT OPERATOR PARAMETERS

The control parameters can be loaded with predetermined default values. These data are the typical values loaded in the instrument prior to shipment from factory. To load the default values proceed as follows:

- The internal switch should be closed.
- The SMART function should be disabled.
- The safety lock must be OFF.
- The display will show the process variable.
- Hold down ▼ pushbutton and press ▲ pushbutton; the display will show:

**d.O F**

- Within 10 seconds press ▲ or ▼ pushbutton. The display will show:

**d.O n**

- Press FUNC pushbutton; the display will show:

**L. d t.**

This means that the loading procedure has been initiated. After about 3 seconds the loading procedure is terminated and the instrument reverts to NORMAL DISPLAY mode.

The following is a list of the default operative parameters loaded during the above procedure:

PARAMETER	DEFAULT VALUE
SP	= minimum range-value
nnn	= OFF
AL	= minimum range-value for process alarms 0 for deviation or band alarms
HSA	= 0.1 %
PB	= 4.0 %
HS	= 0.5 %
ti	= 04.0 (4 minutes)
td	= 1.00 (1 minute)
IP	= 30 % for one control output 0 % for two control outputs
C	= 20 seconds for relay output 2 seconds for SSR output
rL	= initial scale value
rH	= full scale value
OLH	= 100 %
tOL	= infinite

## DEFAULT CONFIGURATION PARAMETERS

The configuration parameters can be loaded with predetermined default values. These data are the typical values loaded in the instrument prior to shipment from factory. To load the default values proceed as follows:

- The internal switch (V2, see fig. 9) should be open.
- The display will show:

**C n F**

- Push the ▼ pushbutton; the display will show the firmware version.

**A. 0 1**

- Maintaining the pressure on the ▼ pushbutton push the ▲ pushbutton also.  
The instrument will show

**d.F F**

- Press ▲ pushbutton to select between table 1 (european) or table 2 (american) default parameter set. The display will show:

**t b. 1**

- Press FUNC pushbutton; the display will show:

**L. d t.**

This means that the loading procedure has been initiated. After about 3 seconds the loading procedure is terminated and the instrument reverts to the "CnF" parameter).

The following is a list of the default parameters loaded during the above procedure:

PARAMETER	TABLE 1	TABLE 2
P1	1	9
P2	0 °C	0 °F
P3	400 °C	999 °F
P4	r	r
P5	0	0
P6	H	H
P7	r	r
P8	OFF	OFF
P9	0	0
P10	0	0
P11	0	0
P12	10	10
P13	2	2
P14	ON	ON
P15	2	2
P16	30.0	30.0
P17	1.0	1.0
P18	--	--
P19	--	--
P20	00.3	00.3
P21	10	10

## **Warranty And Limitation Of Remedy And Reliability**

Chromalox warrants only that the Products and parts manufactured by Chromalox, when shipped, and the work performed by Chromalox when performed, will meet all applicable specification and other specific product and work requirements (including those of performance), if any, and will be free from defects in material and workmanship under normal conditions of use. All claims for defective or non conform, (both hereinafter called defective). Products, parts or work under this warranty must be made in writing immediately upon discovery, and in any event within three (3) years from delivery, provided, however all claims for defective Products and parts must be made writing no later than three (3) years after shipment by Chromalox. Defective and nonconforming items must be held by Chromalox's inspections and returned to the original f.o.b. point upon request. THE FOREGOING IS EXPRESSLY IN LIEU OF ALL OTHER WARRANTIES WHATSOEVER, EXPRESS, IMPLIED AND STATUTORY, INCLUDING, WITHOUT LIMITATION, THE IMPLIED WARRANTIES OF MERCHANT ABILITY AND FITNESS FOR A PARTICULAR PURPOSE.

Notwithstanding the provisions of this WARRANTY AND LIMITATIONS Clause it is specifically understood that Products and parts not manufactured and work not performed by Chromalox are warranted only to the extent and in the manner that the same are warranted to Chromalox by Chromalox's vendors, and then only to the extent that Chromalox is reasonably able to enforce such a warranty, it being understood Chromalox shall have no obligation to initiate litigation unless buyer undertakes to pay all cost and expenses therefore including but not limited to attorney's fees and indemnities Chromalox against any liability to Chromalox's vendors arising out of such litigation.

Upon buyer's submission of a claim as provided above and in its substantiation, Chromalox shall at its option either (i) repair or replace its Products, parts or work at the original f.o.b. point of delivery or (ii) refund an equitable portion of the purchase price. The foregoing is Chromalox's only obligation and buyer's exclusive remedy for breach of warranty, and is buyer's exclusive remedy against Chromalox for all claims arising hereunder or relating hereto whether such claims are based on breach of contract, tort (including negligence and strict liability) or other theories, buyer's failure to submit a claim as provided above shall specifically waive all claims for damages or other relief, including but not limited to claims based on latent defects. In no event shall buyer be entitled to incidental or consequential damages and buyer should hold Chromalox harmless therefrom. Any action by buyer arising hereunder or relating hereto, whether based on breach of contract, tort (including negligence and strict liability) or other theories, must be commenced within three (3) years after the date of shipment or it shall be barred.

## **Returns**

Items returned to Chromalox Instruments and Controls must be accompanied by a Return Authorization Number. This number may be obtained from Chromalox Instruments and Controls, Customer Service Department, Telephone Number (615)793-3900. It should appear on the exterior of the shipping carton and on the shipping documents. Defective items will be repaired or replaced at our option, at no charge.

Return the defective part or product, freight prepaid, to:

Chromalox Instruments and Controls  
1382 Heil-Quaker Blvd.  
LaVergne, TN 37086-3536

# PROHEAT

*Excellence in distribution*

<http://www.proheatinc.com>

117 East Adams Street

P.O. Box 48

LaGrange, KY 40031

Phone (502) 222-1402 Fax (502) 222-0714