

# INSTRUCTIONS FOR THE 1400 SERIES ANALOG SETPOINT TEMPERATURE CONTROL



## LOVE CONTROLS

a Division of Dwyer Instruments, Incorporated  
PO Box 338 ○ Michigan City, IN 46361-0338  
(800) 828-4588 ○ (219) 879-8000 ○ FAX (219) 872-9057  
[www.love-controls.com](http://www.love-controls.com)

March, 2000

949-1131-2

# Contents

MODEL IDENTIFICATION .....	3
INSTALLATION .....	4
WIRING .....	5
WIRING DIAGRAM .....	5
ALARM OUTPUT SETUP .....	6
OUTPUT FUNCTION CHART .....	7
FRONT PANEL FEATURES .....	8
OPERATION .....	8
SPECIFICATIONS .....	9
DIMENSIONS .....	12

# MODEL IDENTIFICATION

**Option Numbers**  
See Option Instructions

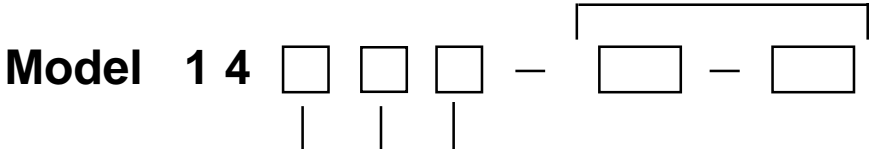

## Aux. Alarm

0 = No  
1 = Yes

## Output

A = Time Proportioning Relay  
B = On-Off Relay  
C = Time Proportioning SSR  
D = On-Off SSR  
E = Time Proportioning Switched Voltage  
F = On-Off Switched Voltage  
G = Proportional 4-20 mADC  
J = Alarm Relay (main)  
K = Alarm SSR (main)  
L = Alarm Switched Voltage (main)

## Range

A = 0 to 400°F/-20 to +200°CJ  
B = 0 to 600°F/-20 to +310°CJ  
C = 0 to 800°F/-20 to +420°CJ  
D = 0 to 1200°F/-20 to +640°CJ  
E = 0 to 1600°F/-20 to +860°CJ  
F = 0 to 800°F/ -20 to +420°CK  
G = 0 to 1200°F/-20 to +640°CK  
H = 0 to 1600°F/-20 to +860°CK  
J = 0 to 2000°F/-20 to +1100°CK  
K = 0 to 2500°F/-20 to +1360°CK  
L = 0 to 200°F/-20 to +90°C RTD  
DIN  
M = 0 to 400°F/-20 to +200°C RTD  
DIN  
N = 0 to 600°F/-20 to +310°C DIN  
RTD  
P = 0 to 800°F/-20 to +420°C RTD  
DIN  
R = -100 to +300°F/-70 to +150°C  
RTD DIN  
S = 0 to 150°F/-20 to +70°C Thms  
Cal 100  
T = +50 to +250°F/+10 to +120°C  
Thms Cal 101  
U = 200 to 600°F/+90 to +310°C  
Thms Cal 109

## OPTIONS:

- 210 Set point knob lock- not available with Auxillary Alarm
- 215 Alarm Power Interrupt.
- 218 Process Signal Output. Non-Isolated 0 to 1 VDC, 0 to 1 mADC
- 2102 FM Approved Setpoint Knob Lock -- not available with Aux. Alarm
- 2502 Control powered from 12 to 24 V AC/DC

## INSTALLATION

Prepare the panel by cutting and deburring the required opening (1.77" x 1.77" / 45mm x 45mm).

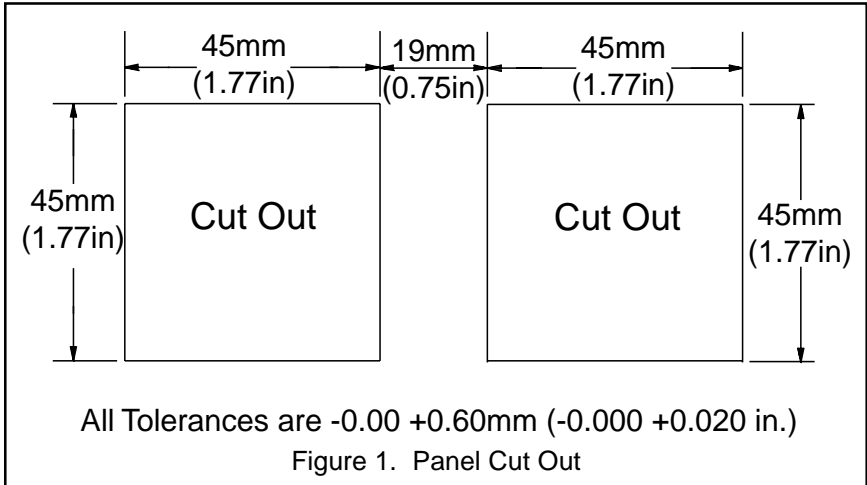

From the front of the panel, slide the housing through the cut out. The housing gasket should be against the housing flange before installing. From the rear of the panel slide the mounting collar over the housing. Hold the housing with one hand and using the other hand, push the collar evenly against the panel until the spring loops are slightly compressed. The ratchets will hold the mounting collar and housing in place.

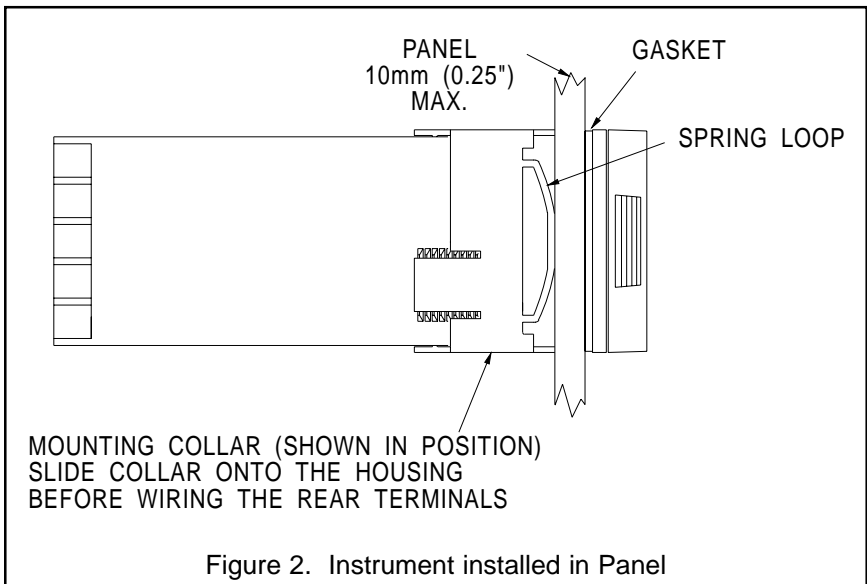

# WIRING

Sensor leads should not run in the same conduit as power leads. Use only the type of sensor specified for your instrument range. Thermocouple input instruments are equipped with automatic sensor break protection. Upon sensor break, the control output to a heating load will turn off.

For 3 wire RTD connect the wires to terminals 1, 2, & 3 as shown. If a 2 wire RTD is being used, connect it across terminals 1 & 2 and either: (1) Run a wire from terminal 3 to the side of the probe that connects to terminal 2 to partially compensate for lead resistance; or (2) Jumper terminal 3 to terminal 2 (will not compensate for lead resistance). RTD input models include sensor open and short protection.

## WIRING DIAGRAMS

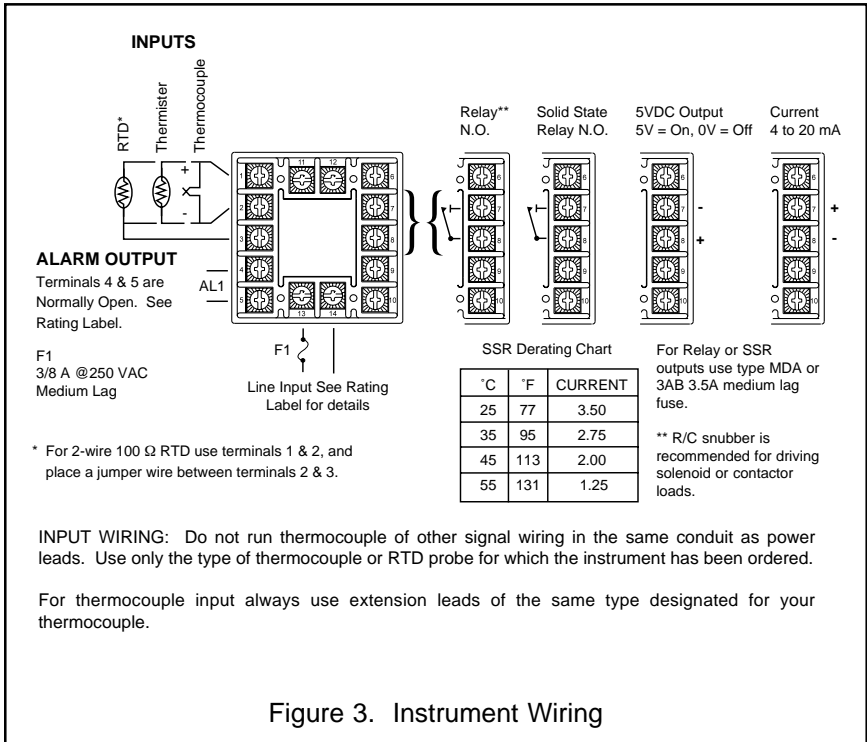
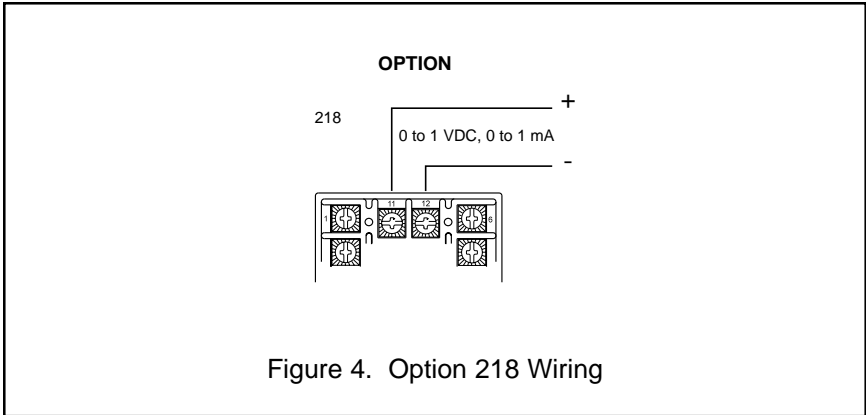

Figure 3. Instrument Wiring



## ALARM OUTPUT SETUP

This output type can be set up to be used in one of four different applications: reverse acting On-Off for heating, direct acting On-Off for cooling, High Alarm, or Low Alarm. The functions are described in the chart (next page). On controls with Auxillary Alarm, the alarm point can be adjusted  $\pm 20\%$  from the main setpoint with the adjustment on the lower left hand corner of the control.

The selection of action and reset functions are set by jumpers which are located on the component side of the circuit board on the right side of the control (see Figure 5 below).

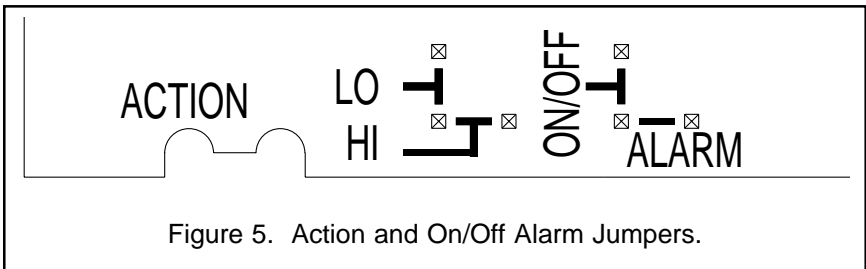

Select the action by placing the ACTION jumper to either LO (direct acting) or HI (reverse acting). The ON/OFF ALARM jumper determines whether the output will reset after the temperature has moved to the other side of the set point. If ON/OFF is selected then the output will automatically reset. If ALARM is selected then the RESET button on the front of the control must be pushed before the output will reset.

# OUTPUT FUNCTION CHART

The following chart describes the function and action of the available outputs. Action of the auxillary alarm is the same as for the alarm outputs. Instructions for setup of the alarm outputs is described on the previous page.

ORDER CODE	CONTROL ACTION	PROP. BAND	ON-OFF DIFFERENTIAL	OUTPUT / LED BELOW SET POINT	OUTPUT / LED AT SET POINT	OUTPUT / LED ABOVE SET POINT
A	Time Proportioning Relay Reverse Acting	3%	N/A	ON	Variable ON/OFF time	OFF
B	ON/OFF Relay Reverse Acting	N/A	Greater of 0.1% of F.S. or 80 $\mu$ V of input	ON	OFF	OFF
C	Time Proportioning SSR Reverse Acting	3%	N/A	ON	Variable ON/OFF time	OFF
D	ON/OFF SSR Reverse Acting	N/A	Greater of 0.1% of F.S. or 80 $\mu$ V of input	ON	OFF	OFF
E	Time Proportioning 5VDC Reverse Acting	3%	N/A	ON	Variable ON/OFF time	OFF
F	ON/OFF 5VDC Reverse Acting	N/A	Greater of 0.1% of F.S. or 80 $\mu$ V of input	ON	OFF	OFF
G	Proportional Current Reverse Acting	5%	N/A	20 mA / Bright	Varies (20-4 mA) / Variable brightness	4 mA / Dim
J	ALARM Relay (Action set for HI)	N/A	Greater of 0.1% of F.S. or 80 $\mu$ V of input	ON	OFF	OFF
K	ALARM SSR (Action set for HI)	N/A	Greater of 0.1% of F.S. or 80 $\mu$ V of input	ON	OFF	OFF
L	ALARM 5VDC (Action set for HI)	N/A	Greater of 0.1% of F.S. or 80 $\mu$ V of input	ON	OFF	OFF
J	ALARM Relay (Action set for LO)	N/A	Greater of 0.1% of F.S. or 80 $\mu$ V of input	OFF	ON	ON
K	ALARM SSR (Action set for LO)	N/A	Greater of 0.1% of F.S. or 80 $\mu$ V of input	OFF	ON	ON
L	ALARM 5VDC (Action set for LO)	N/A	Greater of 0.1% of F.S. or 80 $\mu$ V of input	OFF	ON	ON

## FRONT PANEL FEATURES

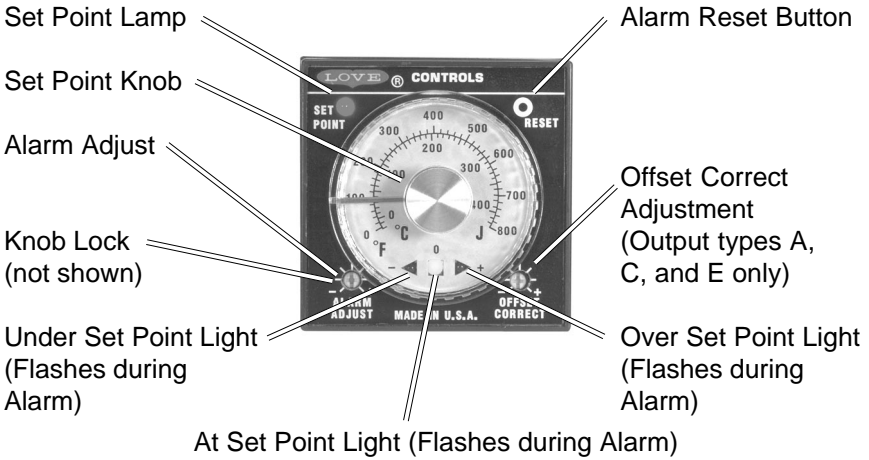

## OPERATION

After Mounting and wiring, adjust the red pointer to the desired set point, power the system. When lit, the status LED indicates that the output is energized. For normal heating control the temperature will start out below the set point, the status LED and the output will be 100% “On”. As the process input approaches the set point the LED and the output will change as described in the chart opposite.

The deviation indicator will show the position of the input. When the deviation indicator green LED is lit, the temperature is within  $\pm 1.5\%$  of set point. If one of the red deviation indicator LEDs are lit, the temperature is above or below the setpoint by more than 1.5%. On controls with alarm, the deviation indicator LEDs will flash to indicate the alarm condition.

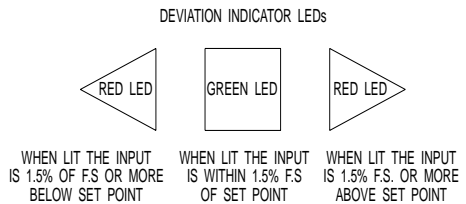

On Time Proportioning and Proportional models if the input stabilizes below the set point then the Offset Correct adjustment should be turned clockwise in small increments until the deviation indicator green LED is lit. If the input stabilizes above the set point then adjust the Offset Correct counterclockwise.



## SPECIFICATIONS

**Inputs:** Thermocouple, RTD, Thermistor

**Input Impedance:**

- Thermocouple = 3 megohms minimum
- RTD current = 500  $\mu$ A maximum
- Thermistor current = 250  $\mu$ A maximum

**Maximum Thermocouple Resistance:** 200 ohms with rated accuracy.

**Supply Voltage:** 100 to 240 VAC nom., +10% -15%, 50-400 Hz. 132 to 240 VDC nom., +10% -20%.

**Supply Voltage (Option 2502):** 12 to 24 Vdc/Vac 50 to 400 Hz,  $\pm$ 20%.

**Power consumption:** 5 VA maximum.

**Line Voltage Stability:**  $\pm$ 0.05% over supply voltage range

**Temperature Stability:** 100ppm/ $^{\circ}$ C typical, 200ppm/ $^{\circ}$ C maximum.

**CMRR:** 140 DB minimum at 60 Hz.

**NMRR:** 65 DB typical, 60 DB at 60 Hz.

**Isolation:** Relay and SSR outputs are isolated. Current or logic outputs must not share common grounds with the input.

**Operating Temperature Range:** -10 to +55 $^{\circ}$ C (+14 to +130 $^{\circ}$  F).

**Storage Temperature Range:** -25 to +65 $^{\circ}$ C (-13 to +149 $^{\circ}$ F).

**Humidity Conditions:** 0 to 90% RH up to 40 $^{\circ}$ C noncondensing, 10 to 50% RH at 55 $^{\circ}$ C noncondensing.

**Control Output Ratings:**

- Solid State Relay: 3.5A at 240 VAC maximum at 25 $^{\circ}$ C typical. Derates to 1.25A at 55 $^{\circ}$ C.
- Relay, Form A contact (SPST):
  - 3A at 250 VAC maximum, resistive.
  - 1.5A at 250 VAC maximum, inductive.
  - Pilot duty rating = 250VA, 2A at 125 VAC or 1A at 250 VAC.
- Current (non-isolated): 4 to 20 mA into 600 ohms maximum.
- Switched Voltage (non-isolated): 5VDC at 25 mA maximum.

**Weight:** 227 g (8 oz.)

**Front Panel Rating (non-hazardous locations):** Meets NEMA 2 and 12 ratings.

**Agency Approvals:** UL E83725, CSA 67L8.

## OPTIONS

One or more of the following options may be found on your control.

210 Set Point knob lock. This option is not available with the Auxillary Alarm. This allows the Set Point knob to be secured in a fixed position to discourage tampering. Loosen the screw in the center of the locking mechanism, adjust the set point knob to the desired setting, and re-tighten the screw. Overtightening will damage the control.

215 Alarm Power Interrupt. This option allows the alarm to be reset on power up if no true alarm condition exists. Operation is automatic. No adjustments are required.

218 Process Signal Output. This is a non-Isolated 0 to 1 VDC, 0 to 1 mADC output signal that tracks the input. This output is not linearized. Input impedance of the recorder (or other receiving device) must be 1000 ohms. This output is available from the Auxillary Input/Output terminals 11 (negative) and 12 (positive).

2102 FM Approved Setpoint Knob Lock. This option is not available with Auxillary Alarm. Similar to option 210 above, option 2102 makes the control an FM Approved limit control and has a set point knob that locks. The knob lock is constructed using special non-standard hex key that can only be tightened or loosened with a special hex key that is shipped with the instrument. The instrument is configured as a high limit at the factory. Spare hex keys can be purchased by our part number 961-0104.

2502 Control powered from 12 to 24 V AC/DC supply. Power to the control is low voltage. In place of line voltage wire the low voltage supply to terminals 13 and 14. The power input can be AC or DC. The input is not polarity sensitive. Note that the output ratings are not changed. The SSR outputs will not switch loads lower than 60 VAC and /or 100 milliamps.

# NOTES

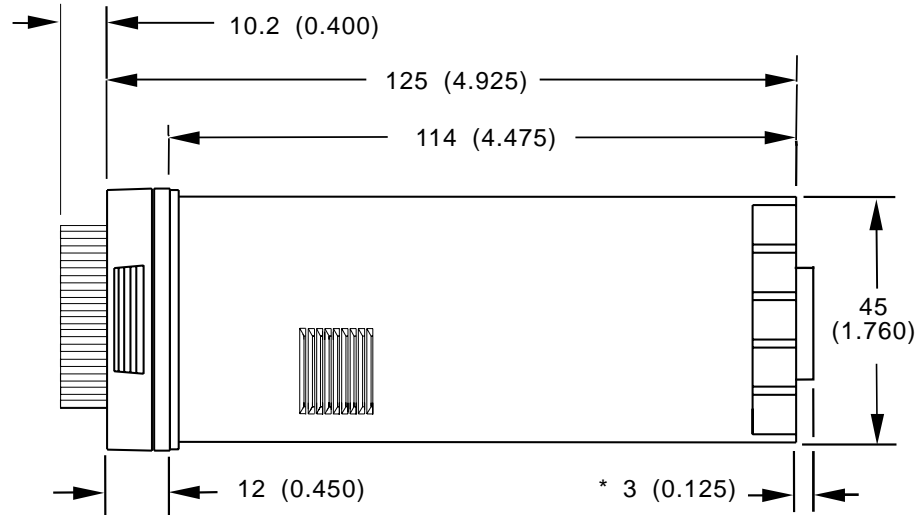
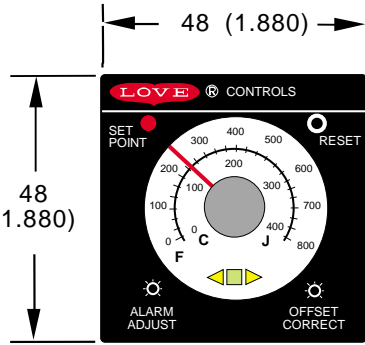

**DIMENSIONS**

Panel cutout for all models is 45mm x 45mm (1.775in x 1.775in).  
 Allow for 13mm (0.5in) clearance at the rear.

\* Present for SSR and Current outputs.

All Dimensions in millimeters with inches in parenthesis.